

Part IV

Flows and Cuts

The following slides are partially based on slides by Kevin Wayne.

10 Introduction

Flow Network

- ▶ directed graph $G = (V, E)$; edge capacities $c(e)$
- ▶ two special nodes: source s ; target t ;
- ▶ no edges entering s or leaving t ;
- ▶ at least for now: no parallel edges;

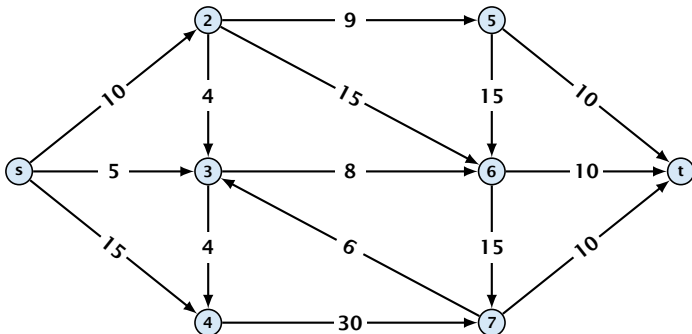

Cuts

Definition 1

An (s, t) -cut in the graph G is given by a set $A \subset V$ with $s \in A$ and $t \in V \setminus A$.

Definition 2

The **capacity** of a cut A is defined as

$$\text{cap}(A, V \setminus A) := \sum_{e \in \text{out}(A)} c(e) ,$$

where $\text{out}(A)$ denotes the set of edges of the form $A \times V \setminus A$ (i.e. edges leaving A).

Minimum Cut Problem: Find an (s, t) -cut with minimum capacity.

Cuts

Example 3

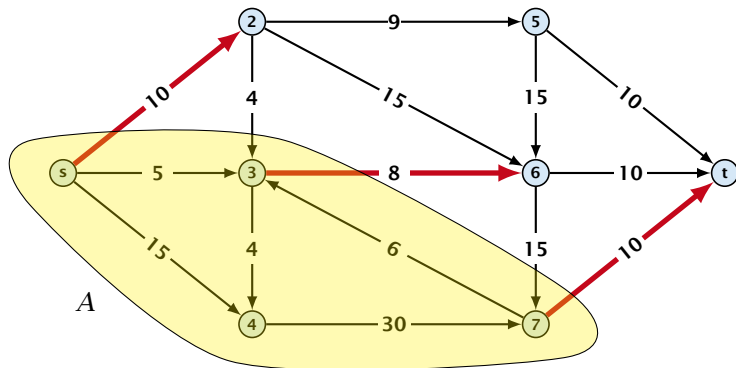

The capacity of the cut is $\text{cap}(A, V \setminus A) = 28$.

Definition 4

An (s, t) -flow is a function $f : E \mapsto \mathbb{R}^+$ that satisfies

1. For each edge e

$$0 \leq f(e) \leq c(e) .$$

(capacity constraints)

2. For each $v \in V \setminus \{s, t\}$

$$\sum_{e \in \text{out}(v)} f(e) = \sum_{e \in \text{into}(v)} f(e) .$$

(flow conservation constraints)

Definition 5

The **value of an (s, t) -flow f** is defined as

$$\text{val}(f) = \sum_{e \in \text{out}(s)} f(e) .$$

Maximum Flow Problem: Find an (s, t) -flow with maximum value.

Example 6

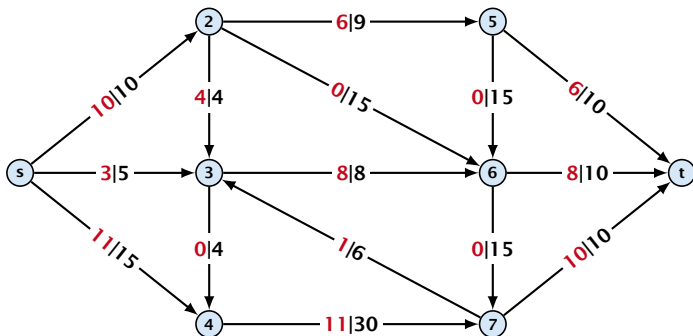

The value of the flow is $\text{val}(f) = 24$.

Lemma 7 (Flow value lemma)

Let f be a flow, and let $A \subseteq V$ be an (s, t) -cut. Then the *net-flow* across the cut is equal to the amount of flow leaving s , i.e.,

$$\text{val}(f) = \sum_{e \in \text{out}(A)} f(e) - \sum_{e \in \text{into}(A)} f(e) .$$

Proof.

$$\begin{aligned}\text{val}(f) &= \sum_{e \in \text{out}(s)} f(e) \\ &= \sum_{e \in \text{out}(s)} f(e) + \sum_{v \in A \setminus \{s\}} \left(\sum_{e \in \text{out}(v)} f(e) - \sum_{e \in \text{in}(v)} f(e) \right) \\ &= \sum_{e \in \text{out}(A)} f(e) - \sum_{e \in \text{into}(A)} f(e)\end{aligned}$$

The last equality holds since every edge with both end-points in A contributes negatively as well as positively to the sum in Line 2. The only edges whose contribution doesn't cancel out are edges leaving or entering A . \square

Example 8

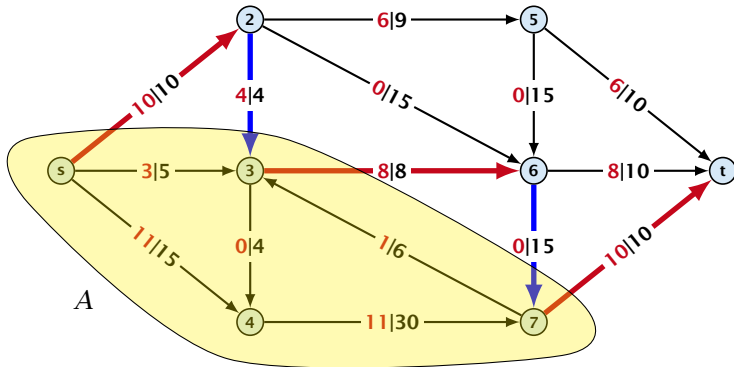

Corollary 9

Let f be an (s, t) -flow and let A be an (s, t) -cut, such that

$$\text{val}(f) = \text{cap}(A, V \setminus A).$$

Then f is a maximum flow.

Proof.

Suppose that there is a flow f' with larger value. Then

$$\begin{aligned} \text{cap}(A, V \setminus A) &< \text{val}(f') \\ &= \sum_{e \in \text{out}(A)} f'(e) - \sum_{e \in \text{into}(A)} f'(e) \\ &\leq \sum_{e \in \text{out}(A)} f'(e) \\ &\leq \text{cap}(A, V \setminus A) \end{aligned}$$



11 Augmenting Path Algorithms

Greedy-algorithm:

- ▶ start with $f(e) = 0$ everywhere
- ▶ find an s - t path with $f(e) < c(e)$ on every edge
- ▶ augment flow along the path
- ▶ repeat as long as possible

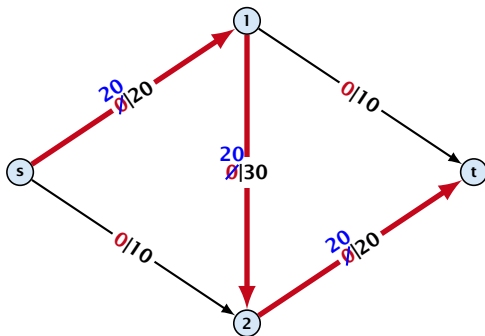

The Residual Graph

From the graph $G = (V, E, c)$ and the current flow f we construct an auxiliary graph $G_f = (V, E_f, c_f)$ (the residual graph):

- ▶ Suppose the original graph has edges $e_1 = (u, v)$, and $e_2 = (v, u)$ between u and v .
- ▶ G_f has edge e'_1 with capacity $\max\{0, c(e_1) - f(e_1) + f(e_2)\}$ and e'_2 with with capacity $\max\{0, c(e_2) - f(e_2) + f(e_1)\}$.

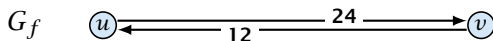
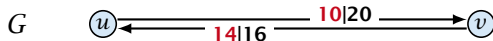

Augmenting Path Algorithm

Definition 10

An **augmenting path** with respect to flow f , is a path from s to t in the auxiliary graph G_f that contains only edges with non-zero capacity.

Algorithm 1 FordFulkerson($G = (V, E, c)$)

- 1: Initialize $f(e) \leftarrow 0$ for all edges.
- 2: **while** \exists augmenting path p in G_f **do**
- 3: augment as much flow along p as possible.

Augmenting Path Algorithm

Animation for augmenting path algorithms is only available in the lecture version of the slides.

Augmenting Path Algorithm

Theorem 11

A flow f is a maximum flow **iff** there are no augmenting paths.

Theorem 12

The value of a maximum flow is equal to the value of a minimum cut.

Proof.

Let f be a flow. The following are equivalent:

1. There exists a cut A such that $\text{val}(f) = \text{cap}(A, V \setminus A)$.
2. Flow f is a maximum flow.
3. There is no augmenting path w.r.t. f .



Augmenting Path Algorithm

1. \Rightarrow 2.

This we already showed.

2. \Rightarrow 3.

If there were an augmenting path, we could improve the flow.
Contradiction.

3. \Rightarrow 1.

- ▶ Let f be a flow with no augmenting paths.
- ▶ Let A be the set of vertices reachable from s in the residual graph along non-zero capacity edges.
- ▶ Since there is no augmenting path we have $s \in A$ and $t \notin A$.

Augmenting Path Algorithm

$$\begin{aligned}\text{val}(f) &= \sum_{e \in \text{out}(A)} f(e) - \sum_{e \in \text{into}(A)} f(e) \\ &= \sum_{e \in \text{out}(A)} c(e) \\ &= \text{cap}(A, V \setminus A)\end{aligned}$$

This finishes the proof.

Here the first equality uses the flow value lemma, and the second exploits the fact that the flow along incoming edges must be 0 as the residual graph does not have edges leaving A .

Analysis

Assumption:

All capacities are integers between 1 and C .

Invariant:

Every flow value $f(e)$ and every residual capacity $c_f(e)$ remains integral throughout the algorithm.

Lemma 13

The algorithm terminates in at most $\text{val}(f^*) \leq nC$ iterations, where f^* denotes the maximum flow. Each iteration can be implemented in time $\mathcal{O}(m)$. This gives a total running time of $\mathcal{O}(nmC)$.

Theorem 14

If all capacities are integers, then there exists a maximum flow for which every flow value $f(e)$ is integral.

A Bad Input

Problem: The running time may not be polynomial.

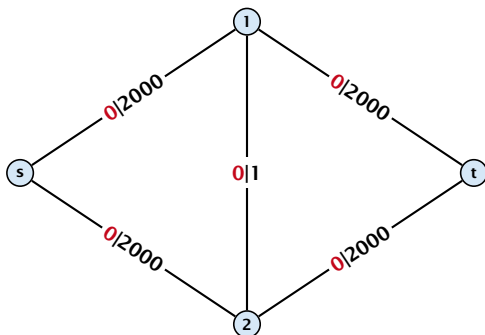

Question:

Can we tweak the algorithm so that the running time is polynomial in the input length?

A Bad Input

Problem: The running time may not be polynomial.

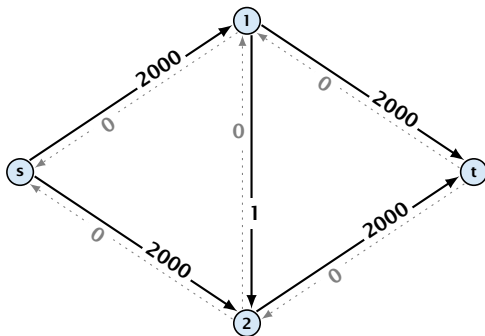

Question:

Can we tweak the algorithm so that the running time is polynomial in the input length?

See the lecture-version of the slides for the animation.

A Pathological Input

Let $r = \frac{1}{2}(\sqrt{5} - 1)$. Then $r^{n+2} = r^n - r^{n+1}$.

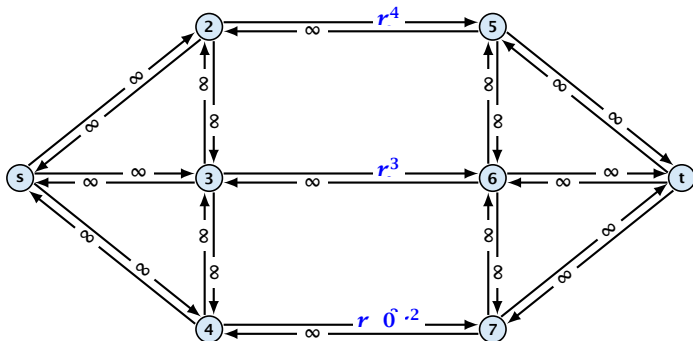

Running time may be infinite!!!

See the lecture-version of the slides for the animation.

How to choose augmenting paths?

- ▶ We need to find paths efficiently.
- ▶ We want to guarantee a small number of iterations.

Several possibilities:

- ▶ Choose path with maximum bottleneck capacity.
- ▶ Choose path with sufficiently large bottleneck capacity.
- ▶ Choose the shortest augmenting path.

Overview: Shortest Augmenting Paths

Lemma 15

The length of the shortest augmenting path never decreases.

Lemma 16

After at most $\mathcal{O}(m)$ augmentations, the length of the shortest augmenting path strictly increases.

Overview: Shortest Augmenting Paths

These two lemmas give the following theorem:

Theorem 17

The shortest augmenting path algorithm performs at most $\mathcal{O}(mn)$ augmentations. This gives a running time of $\mathcal{O}(m^2n)$.

Proof.

- ▶ We can find the shortest augmenting paths in time $\mathcal{O}(m)$ via BFS.
- ▶ $\mathcal{O}(m)$ augmentations for paths of exactly $k < n$ edges.



Shortest Augmenting Paths

Define the level $\ell(v)$ of a node as the length of the shortest s - v path in G_f .

Let L_G denote the **subgraph** of the residual graph G_f that contains only those edges (u, v) with $\ell(v) = \ell(u) + 1$.

A path P is a shortest s - t path in G_f if it is an s - t path in L_G .

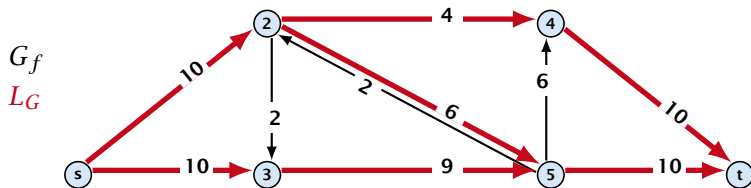

In the following we assume that the residual graph G_f does not contain zero capacity edges.

This means, we construct it in the usual sense and then delete edges of zero capacity.

Shortest Augmenting Path

First Lemma:

The length of the shortest augmenting path never decreases.

After an augmentation G_f changes as follows:

- ▶ Bottleneck edges on the chosen path are deleted.
- ▶ Back edges are added to all edges that don't have back edges so far.

These changes cannot decrease the distance between s and t .

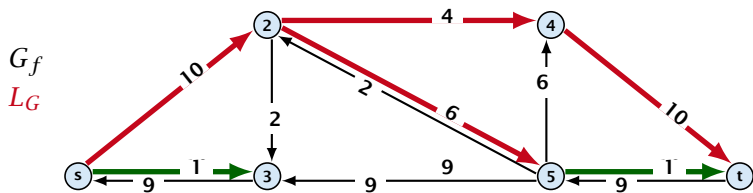

Shortest Augmenting Path

Second Lemma: After at most m augmentations the length of the shortest augmenting path strictly increases.

Let E_L denote the set of edges in graph L_G at the beginning of a round when the distance between s and t is k .

An s - t path in G_f that uses edges not in E_L has length larger than k , even when considering edges added to G_f during the round.

In each augmentation one edge is deleted from E_L .

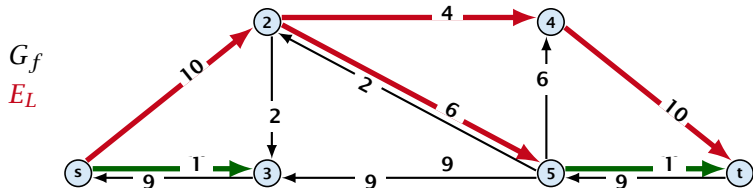

Shortest Augmenting Paths

Theorem 18

The shortest augmenting path algorithm performs at most $\mathcal{O}(mn)$ augmentations. Each augmentation can be performed in time $\mathcal{O}(m)$.

Theorem 19 (without proof)

There exist networks with $m = \Theta(n^2)$ that require $\mathcal{O}(mn)$ augmentations, when we restrict ourselves to only augment along shortest augmenting paths.

Note:

There always exists a set of m augmentations that gives a maximum flow (why?).

Shortest Augmenting Paths

When sticking to shortest augmenting paths we cannot improve (asymptotically) on the number of augmentations.

However, we can improve the running time to $\mathcal{O}(mn^2)$ by improving the running time for finding an augmenting path (currently we assume $\mathcal{O}(m)$ per augmentation for this).

Shortest Augmenting Paths

We maintain a subset E_L of the edges of G_f with the guarantee that a shortest $s-t$ path using only edges from E_L is a shortest augmenting path.

With each augmentation some edges are deleted from E_L .

When E_L does not contain an $s-t$ path anymore the distance between s and t strictly increases.

Note that E_L is not the set of edges of the level graph but a subset of level-graph edges.

Suppose that the initial distance between s and t in G_f is k .

E_L is initialized as the level graph L_G .

Perform a **DFS search** to find a path from s to t using edges from E_L .

Either you find t after at most n steps, or you end at a node v that does not have any outgoing edges.

You can delete incoming edges of v from E_L .

Let a phase of the algorithm be defined by the time between two augmentations during which the distance between s and t strictly increases.

Initializing E_L for the phase takes time $\mathcal{O}(m)$.

The total cost for searching for augmenting paths during a phase is at most $\mathcal{O}(mn)$, since every search (successful (i.e., reaching t) or unsuccessful) decreases the number of edges in E_L and takes time $\mathcal{O}(n)$.

The total cost for performing an augmentation **during** a phase is only $\mathcal{O}(n)$. For every edge in the augmenting path one has to update the residual graph G_f and has to check whether the edge is still in E_L for the next search.

There are at most n phases. Hence, total cost is $\mathcal{O}(mn^2)$.

How to choose augmenting paths?

- ▶ We need to find paths efficiently.
- ▶ We want to guarantee a small number of iterations.

Several possibilities:

- ▶ Choose path with maximum bottleneck capacity.
- ▶ Choose path with sufficiently large bottleneck capacity.
- ▶ Choose the shortest augmenting path.

Capacity Scaling

Intuition:

- ▶ Choosing a path with the highest bottleneck increases the flow as much as possible in a single step.
- ▶ Don't worry about finding the exact bottleneck.
- ▶ Maintain scaling parameter Δ .
- ▶ $G_f(\Delta)$ is a sub-graph of the residual graph G_f that contains only edges with capacity at least Δ .

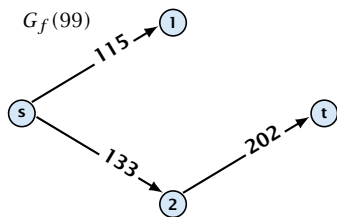
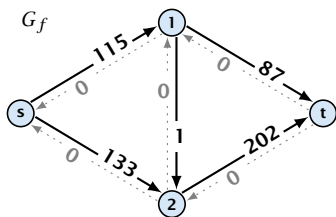

Capacity Scaling

Algorithm 2 $\text{maxflow}(G, s, t, c)$

```
1: foreach  $e \in E$  do  $f_e \leftarrow 0$ ;  
2:  $\Delta \leftarrow 2^{\lceil \log_2 C \rceil}$   
3: while  $\Delta \geq 1$  do  
4:    $G_f(\Delta) \leftarrow \Delta$ -residual graph  
5:   while there is augmenting path  $P$  in  $G_f(\Delta)$  do  
6:      $f \leftarrow \text{augment}(f, c, P)$   
7:      $\text{update}(G_f(\Delta))$   
8:    $\Delta \leftarrow \Delta/2$   
9: return  $f$ 
```

Capacity Scaling

Assumption:

All capacities are integers between 1 and C .

Invariant:

All flows and capacities are/remain integral throughout the algorithm.

Correctness:

The algorithm computes a maxflow:

- ▶ because of integrality we have $G_f(1) = G_f$
- ▶ therefore after the last phase there are no augmenting paths anymore
- ▶ this means we have a maximum flow.

Capacity Scaling

Lemma 20

There are $\lceil \log C \rceil + 1$ iterations over Δ .

Proof: obvious.

Lemma 21

Let f be the flow at the end of a Δ -phase. Then the maximum flow is smaller than $\text{val}(f) + m\Delta$.

Proof: less obvious, but simple:

- ▶ There must exist an s - t cut in $G_f(\Delta)$ of zero capacity.
- ▶ In G_f this cut can have capacity at most $m\Delta$.
- ▶ This gives me an upper bound on the flow that I can still add.

Capacity Scaling

Lemma 22

There are at most $2m$ augmentations per scaling-phase.

Proof:

- ▶ Let f be the flow at the end of the previous phase.
- ▶ $\text{val}(f^*) \leq \text{val}(f) + 2m\Delta$
- ▶ Each augmentation increases flow by Δ .

Theorem 23

We need $\mathcal{O}(m \log C)$ augmentations. The algorithm can be implemented in time $\mathcal{O}(m^2 \log C)$.

Matching

- ▶ Input: undirected graph $G = (V, E)$.
- ▶ $M \subseteq E$ is a **matching** if each node appears in at most one edge in M .
- ▶ Maximum Matching: find a matching of maximum cardinality

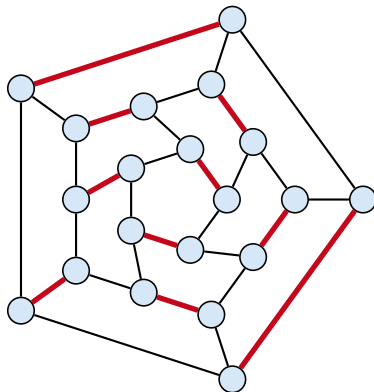

Bipartite Matching

- ▶ Input: undirected, **bipartite** graph $G = (L \uplus R, E)$.
- ▶ $M \subseteq E$ is a **matching** if each node appears in at most one edge in M .
- ▶ **Maximum Matching**: find a matching of maximum cardinality

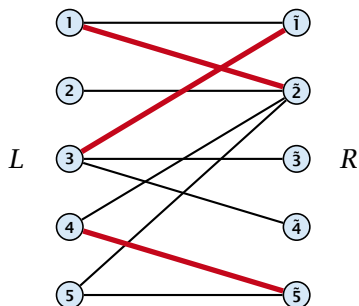

Bipartite Matching

- ▶ Input: undirected, **bipartite** graph $G = (L \uplus R, E)$.
- ▶ $M \subseteq E$ is a **matching** if each node appears in at most one edge in M .
- ▶ Maximum Matching: find a matching of maximum cardinality

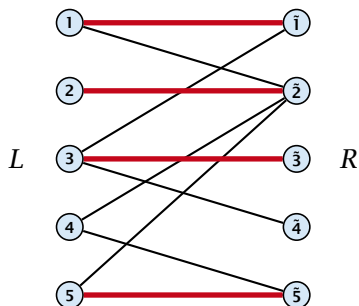

Maxflow Formulation

- ▶ Input: undirected, bipartite graph $G = (L \uplus R \uplus \{s, t\}, E')$.
- ▶ Direct all edges from L to R .
- ▶ Add source s and connect it to all nodes on the left.
- ▶ Add t and connect all nodes on the right to t .
- ▶ All edges have unit capacity.

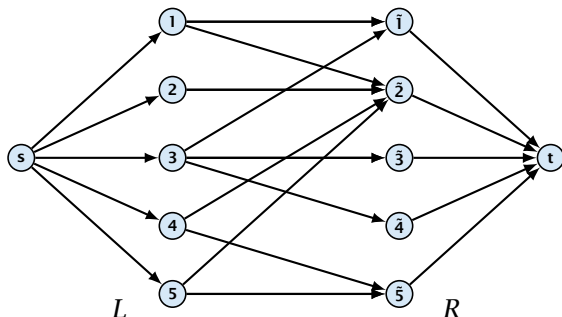

Proof

Max cardinality matching in $G \leq$ value of maxflow in G'

- ▶ Given a maximum matching M of cardinality k .
- ▶ Consider flow f that sends one unit along each of k paths.
- ▶ f is a flow and has cardinality k .

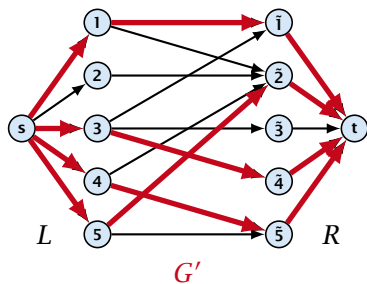
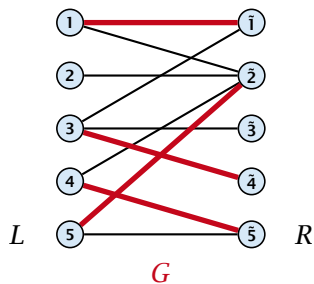

Proof

Max cardinality matching in $G \geq$ value of maxflow in G'

- ▶ Let f be a maxflow in G' of value k
- ▶ Integrality theorem $\Rightarrow k$ integral; we can assume f is 0/1.
- ▶ Consider $M =$ set of edges from L to R with $f(e) = 1$.
- ▶ Each node in L and R participates in at most one edge in M .
- ▶ $|M| = k$, as the flow must use at least k middle edges.

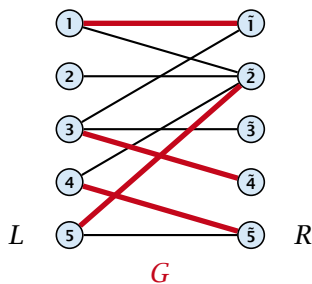
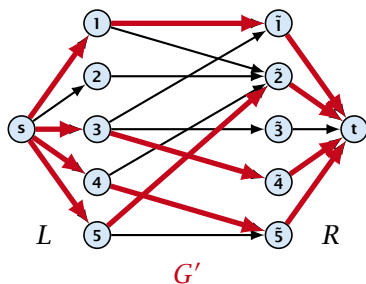

12.1 Matching

Which flow algorithm to use?

- ▶ Generic augmenting path: $\mathcal{O}(m \text{val}(f^*)) = \mathcal{O}(mn)$.
- ▶ Capacity scaling: $\mathcal{O}(m^2 \log C) = \mathcal{O}(m^2)$.
- ▶ Shortest augmenting path: $\mathcal{O}(mn^2)$.

For **unit capacity simple graphs** shortest augmenting path can be implemented in time $\mathcal{O}(m\sqrt{n})$.

A graph is a **unit capacity simple graph** if

- ▶ every edge has capacity 1
- ▶ a node has either at most one leaving edge **or** at most one entering edge

Baseball Elimination

<i>team</i> <i>i</i>	<i>wins</i> w_i	<i>losses</i> ℓ_i	<i>remaining games</i>			
			<i>Atl</i>	<i>Phi</i>	<i>NY</i>	<i>Mon</i>
Atlanta	83	71	–	1	6	1
Philadelphia	80	79	1	–	0	2
New York	78	78	6	0	–	0
Montreal	77	82	1	2	0	–

Which team can end the season with most wins?

- ▶ Montreal is eliminated, since even after winning all remaining games there are only 80 wins.
- ▶ But also Philadelphia is eliminated. Why?

Baseball Elimination

Formal definition of the problem:

- ▶ Given a set S of teams, and one specific team $z \in S$.
- ▶ Team x has already won w_x games.
- ▶ Team x still has to play team y , r_{xy} times.
- ▶ Does team z still have a chance to finish with the most number of wins.

Baseball Elimination

Flow network for $z = 3$. M is number of wins Team 3 can still obtain.

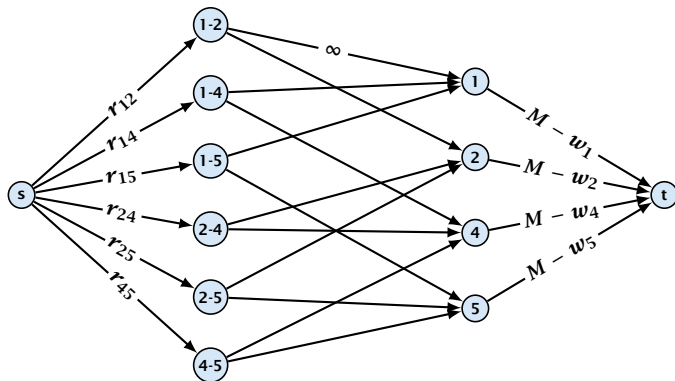

Idea. Distribute the results of remaining games in such a way that no team gets too many wins.

Certificate of Elimination

Let $T \subseteq S$ be a subset of teams. Define

$$w(T) := \sum_{i \in T} w_i, \quad r(T) := \sum_{i, j \in T, i < j} r_{ij}$$

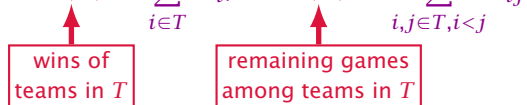

If $\frac{w(T)+r(T)}{|T|} > M$ then one of the teams in T will have more than M wins in the end. A team that can win at most M games is therefore eliminated.

Theorem 24

A team z is eliminated if and only if the flow network for z does not allow a flow of value $\sum_{i \in S \setminus \{z\}, i < j} r_{ij}$.

Proof (\Leftarrow)

- ▶ Consider the mincut A in the flow network. Let T be the set of team-nodes in A .
- ▶ If for node $x-y$ not both team-nodes x and y are in T , then $x-y \notin A$ as otherwise the cut would cut an infinite capacity edge.
- ▶ We don't find a flow that saturates all source edges:

$$\begin{aligned}r(S \setminus \{z\}) &> \text{cap}(A, V \setminus A) \\ &\geq \sum_{i < j: i \notin T \vee j \notin T} r_{ij} + \sum_{i \in T} (M - w_i) \\ &\geq r(S \setminus \{z\}) - r(T) + |T|M - w(T)\end{aligned}$$

- ▶ This gives $M < (w(T) + r(T))/|T|$, i.e., z is eliminated.

Baseball Elimination

Proof (\Rightarrow)

- ▶ Suppose we have a flow that saturates all source edges.
- ▶ We can assume that this flow is **integral**.
- ▶ For every pairing x - y it defines how many games team x and team y should win.
- ▶ The flow leaving the team-node x can be interpreted as the additional number of wins that team x will obtain.
- ▶ This is less than $M - w_x$ because of capacity constraints.
- ▶ Hence, we found a set of results for the remaining games, such that no team obtains more than M wins in total.
- ▶ Hence, team z is not eliminated.

Project Selection

Project selection problem:

- ▶ Set P of possible projects. Project v has an associated profit p_v (can be positive or negative).
- ▶ Some projects have requirements (taking course EA2 requires course EA1).
- ▶ Dependencies are modelled in a graph. Edge (u, v) means “can’t do project u without also doing project v .”
- ▶ A subset A of projects is **feasible** if the prerequisites of every project in A also belong to A .

Goal: Find a feasible set of projects that maximizes the profit.

Project Selection

The prerequisite graph:

- ▶ $\{x, a, z\}$ is a feasible subset.
- ▶ $\{x, a\}$ is infeasible.

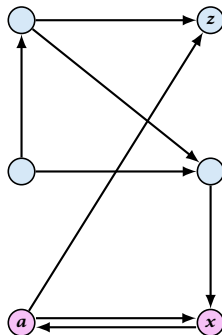
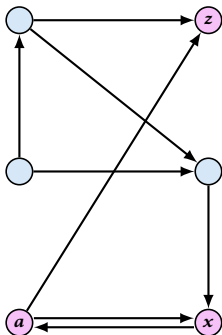

Project Selection

Mincut formulation:

- ▶ Edges in the prerequisite graph get infinite capacity.
- ▶ Add edge (s, v) with capacity p_v for nodes v with positive profit.
- ▶ Create edge (v, t) with capacity $-p_v$ for nodes v with negative profit.

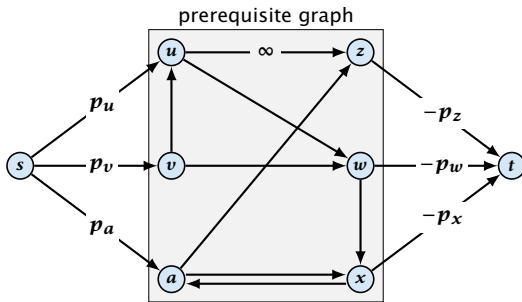

Theorem 25

A is a mincut if $A \setminus \{s\}$ is the optimal set of projects.

Proof.

▶ A is feasible because of capacity infinity edges.

$$\text{cap}(A, V \setminus A) = \sum_{v \in \bar{A}: p_v > 0} p_v + \sum_{v \in A: p_v < 0} (-p_v)$$

$$= \sum_{v: p_v > 0} p_v - \sum_{v \in A} p_v$$

For the formula we define $p_s := 0$.

The step follows by adding $\sum_{v \in A: p_v > 0} p_v - \sum_{v \in A: p_v > 0} p_v = 0$.

Note that minimizing the capacity of the cut $(A, V \setminus A)$ corresponds to maximizing profits of projects in A .

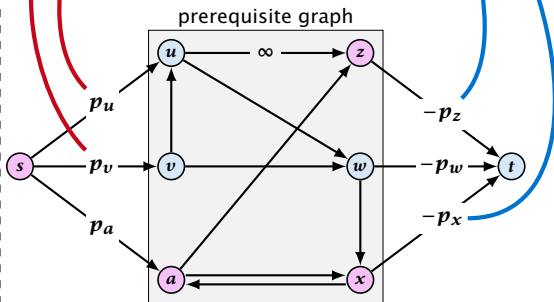

Definition 26

An (s, t) -preflow is a function $f : E \mapsto \mathbb{R}^+$ that satisfies

1. For each edge e

$$0 \leq f(e) \leq c(e) .$$

(capacity constraints)

2. For each $v \in V \setminus \{s, t\}$

$$\sum_{e \in \text{out}(v)} f(e) \leq \sum_{e \in \text{into}(v)} f(e) .$$

Preflows

Example 27

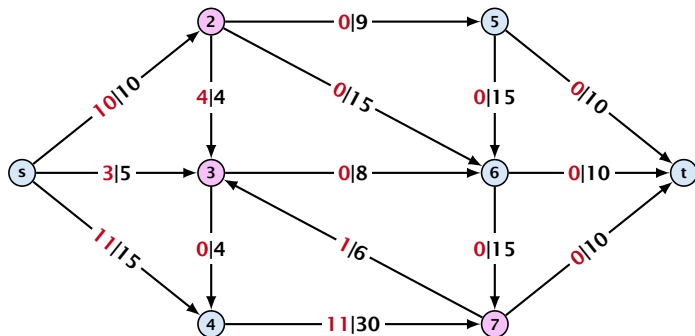

A node that has $\sum_{e \in \text{out}(v)} f(e) < \sum_{e \in \text{into}(v)} f(e)$ is called an **active node**.

Definition:

A **labelling** is a function $\ell : V \rightarrow \mathbb{N}$. It is **valid** for preflow f if

- ▶ $\ell(u) \leq \ell(v) + 1$ for all edges (u, v) in the residual graph G_f (only non-zero capacity edges!!!)
- ▶ $\ell(s) = n$
- ▶ $\ell(t) = 0$

Intuition:

The labelling can be viewed as a height function. Whenever the height from node u to node v decreases by more than 1 (i.e., it goes very steep downhill from u to v), the corresponding edge must be saturated.

Preflows

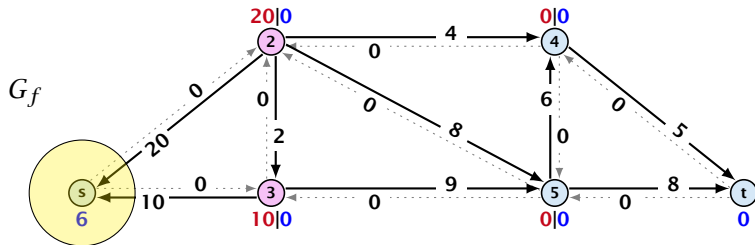
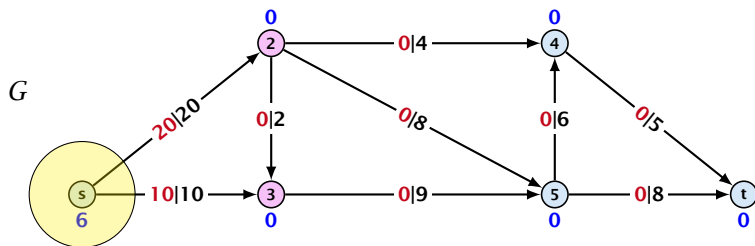

Preflows

Lemma 28

A *preflow* that has a valid labelling saturates a cut.

Proof:

- ▶ There are n nodes but $n + 1$ different labels from $0, \dots, n$.
- ▶ There must exist a label $d \in \{0, \dots, n\}$ such that none of the nodes carries this label.
- ▶ Let $A = \{v \in V \mid \ell(v) > d\}$ and $B = \{v \in V \mid \ell(v) < d\}$.
- ▶ We have $s \in A$ and $t \in B$ and there is no edge from A to B in the residual graph G_f ; this means that (A, B) is a saturated cut.

Lemma 29

A *flow* that has a valid labelling is a maximum flow.

Push Relabel Algorithms

Idea:

- ▶ start with some preflow and some valid labelling
- ▶ successively change the preflow while maintaining a valid labelling
- ▶ stop when you have a flow (i.e., no more active nodes)

Note that this is somewhat dual to an augmenting path algorithm. The former maintains the property that it has a feasible flow. It successively changes this flow until it saturates some cut in which case we conclude that the flow is maximum. A preflow push algorithm maintains the property that it has a saturated cut. The preflow is changed iteratively until it fulfills conservation constraints in which case we can conclude that we have a maximum flow.

Changing a Preflow

An arc (u, v) with $c_f(u, v) > 0$ in the residual graph is **admissible** if $\ell(u) = \ell(v) + 1$ (i.e., it goes downwards w.r.t. labelling ℓ).

The push operation

Consider an active node u with **excess flow**

$f(u) = \sum_{e \in \text{into}(u)} f(e) - \sum_{e \in \text{out}(u)} f(e)$ and suppose $e = (u, v)$ is an admissible arc with residual capacity $c_f(e)$.

We can send flow $\min\{c_f(e), f(u)\}$ along e and obtain a new preflow. The old labelling is still valid (!!!).

- ▶ **saturating push**: $\min\{f(u), c_f(e)\} = c_f(e)$
the arc e is deleted from the residual graph
- ▶ **non-saturating push**: $\min\{f(u), c_f(e)\} = f(u)$
the node u becomes inactive

Note that a push-operation may be saturating **and** non-saturating at the same time.

Push Relabel Algorithms

The relabel operation

Consider an active node u that does not have an outgoing admissible arc.

Increasing the label of u by 1 results in a valid labelling.

- ▶ Edges (w, u) incoming to u still fulfill their constraint $\ell(w) \leq \ell(u) + 1$.
- ▶ An outgoing edge (u, w) had $\ell(u) < \ell(w) + 1$ before since it was not admissible. Now: $\ell(u) \leq \ell(w) + 1$.

Push Relabel Algorithms

Intuition:

We want to send flow downwards, since the source has a height/label of n and the target a height/label of 0 . If we see an active node u with an admissible arc we push the flow at u towards the other end-point that has a lower height/label. If we do not have an admissible arc but excess flow into u it should roughly mean that the level/height/label of u should rise. (If we consider the flow to be water then this would be natural.)

Note that the above intuition is very incorrect as the labels are integral, i.e., they cannot really be seen as the height of a node.

Reminder

- ▶ In a **preflow** nodes may not fulfill conservation constraints; a node may have more incoming flow than outgoing flow.
- ▶ Such a node is called **active**.
- ▶ A labelling is **valid** if for every edge (u, v) in the residual graph $\ell(u) \leq \ell(v) + 1$.
- ▶ An arc (u, v) in residual graph is **admissible** if $\ell(u) = \ell(v) + 1$.
- ▶ A **saturating push** along e pushes an amount of $c(e)$ flow along the edge, thereby saturating the edge (and making it disappear from the residual graph).
- ▶ A **non-saturating push** along $e = (u, v)$ pushes a flow of $f(u)$, where $f(u)$ is the **excess flow** of u . This makes u inactive.

Push Relabel Algorithms

Algorithm 3 $\text{maxflow}(G, s, t, c)$

```
1: find initial preflow  $f$ 
2: while there is active node  $u$  do
3:     if there is admiss. arc  $e$  out of  $u$  then
4:          $\text{push}(G, e, f, c)$ 
5:     else
6:          $\text{relabel}(u)$ 
7: return  $f$ 
```

In the following example we always stick to the same active node u until it becomes inactive but this is not required.

Preflow Push Algorithm

Animation for push relabel algorithms is only available in the lecture version of the slides.

Analysis

Note that the lemma is almost trivial. A node v having excess flow means that the current preflow ships something to v . The residual graph allows to *undo* flow. Therefore, there must exist a path that can undo the shipment and move it back to s . However, a formal proof is required.

Lemma 30

An active node has a path to s in the residual graph.

Proof.

- ▶ Let A denote the set of nodes that can reach s , and let B denote the remaining nodes. Note that $s \in A$.
- ▶ In the following we show that a node $b \in B$ has excess flow $f(b) = 0$ which gives the lemma.
- ▶ In the residual graph there are no edges into A , and, hence, no edges leaving A /entering B can carry any flow.
- ▶ Let $f(B) = \sum_{v \in B} f(v)$ be the excess flow of all nodes in B .

Let $f : E \rightarrow \mathbb{R}_0^+$ be a preflow. We introduce the notation

$$f(x, y) = \begin{cases} 0 & (x, y) \notin E \\ f((x, y)) & (x, y) \in E \end{cases}$$

We have

$$\begin{aligned} f(B) &= \sum_{b \in B} f(b) \\ &= \sum_{b \in B} \left(\sum_{v \in V} f(v, b) - \sum_{v \in V} f(b, v) \right) \\ &= \sum_{b \in B} \left(\sum_{v \in A} f(v, b) + \sum_{v \in B} f(v, b) - \sum_{v \in A} f(b, v) - \sum_{v \in B} f(b, v) \right) \\ &= \sum_{b \in B} \sum_{v \in A} f(b, v) \\ &\leq 0 \end{aligned}$$

Hence, the excess flow $f(b)$ must be 0 for every node $b \in B$.

Analysis

Lemma 31

The label of a node cannot become larger than $2n - 1$.

Proof.

- ▶ When increasing the label at a node u there exists a path from u to s of length at most $n - 1$. Along each edge of the path the height/label can at most drop by 1 , and the label of the source is n .

Lemma 32

There are only $\mathcal{O}(n^2)$ relabel operations.

Analysis

Lemma 33

The number of *saturating pushes* performed is at most $\mathcal{O}(mn)$.

Proof.

- ▶ Suppose that we just made a saturating push along (u, v) .
- ▶ Hence, the edge (u, v) is deleted from the residual graph.
- ▶ For the edge to appear again, a push from v to u is required.
- ▶ Currently, $\ell(u) = \ell(v) + 1$, as we only make pushes along admissible edges.
- ▶ For a push from v to u the edge (v, u) must become admissible. The label of v must increase by at least 2.
- ▶ Since the label of v is at most $2n - 1$, there are at most n pushes along (u, v) .

Lemma 34

The number of *non-saturating pushes* performed is at most $\mathcal{O}(n^2m)$.

Proof.

- ▶ Define a potential function $\Phi(f) = \sum_{\text{active nodes } v} \ell(v)$
- ▶ A saturating push increases Φ by $\leq 2n$ (when the target node becomes active it may contribute at most $2n$ to the sum).
- ▶ A relabel increases Φ by at most 1 .
- ▶ A non-saturating push decreases Φ by at least 1 as the node that is pushed from becomes inactive and has a label that is strictly larger than the target.
- ▶ Hence,

$$\begin{aligned} \# \text{non-saturating_pushes} &\leq \# \text{relabels} + 2n \cdot \# \text{saturating_pushes} \\ &\leq \mathcal{O}(n^2m) . \end{aligned}$$

Theorem 35

There is an implementation of the generic push relabel algorithm with running time $\mathcal{O}(n^2m)$.

Analysis

Proof:

For every node maintain a list of admissible edges starting at that node. Further maintain a list of active nodes.

A push along an edge (u, v) can be performed in constant time

- ▶ check whether edge (v, u) needs to be added to G_f
- ▶ check whether (u, v) needs to be deleted (saturating push)
- ▶ check whether u becomes inactive and has to be deleted from the set of active nodes

A relabel at a node u can be performed in time $\mathcal{O}(n)$

- ▶ check for all outgoing edges if they become admissible
- ▶ check for all incoming edges if they become non-admissible

Analysis

For special variants of push relabel algorithms we organize the neighbours of a node into a linked list (possible neighbours in the residual graph G_f). Then we use the discharge-operation:

Algorithm 4 discharge(u)

```
1: while  $u$  is active do  
2:    $v \leftarrow u.current\text{-neighbour}$   
3:   if  $v = \text{null}$  then  
4:     relabel( $u$ )  
5:      $u.current\text{-neighbour} \leftarrow u.neighbour\text{-list-head}$   
6:   else  
7:     if  $(u, v)$  admissible then push( $u, v$ )  
8:     else  $u.current\text{-neighbour} \leftarrow v.next\text{-in-list}$ 
```

Note that $u.current\text{-neighbour}$ is a global variable. It is only changed within the discharge routine, but keeps its value between consecutive calls to discharge.

Lemma 36

If $v = \text{null}$ in Line 3, then there is no outgoing admissible edge from u .

Proof.

- ▶ While pushing from u the current-neighbour pointer is only advanced if the current edge is not admissible.
- ▶ The only thing that could make the edge admissible again would be a relabel at u .
- ▶ If we reach the end of the list ($v = \text{null}$) all edges are not admissible. □

This shows that $\text{discharge}(u)$ is correct, and that we can perform a relabel in Line 4.

In order for e to become admissible the other end-point say v has to push flow to u (so that the edge (u, v) re-appears in the residual graph). For this the label of v needs to be larger than the label of u . Then in order to make (u, v) admissible the label of u has to increase.

13.2 Relabel to Front

Algorithm 21 relabel-to-front(G, s, t)

```
1: initialize preflow
2: initialize node list  $L$  containing  $V \setminus \{s, t\}$  in any order
3: foreach  $u \in V \setminus \{s, t\}$  do
4:    $u.current-neighbour \leftarrow u.neighbour-list-head$ 
5:  $u \leftarrow L.head$ 
6: while  $u \neq null$  do
7:    $old-height \leftarrow \ell(u)$ 
8:   discharge( $u$ )
9:   if  $\ell(u) > old-height$  then // relabel happened
10:    move  $u$  to the front of  $L$ 
11:    $u \leftarrow u.next$ 
```

13.2 Relabel to Front

Lemma 37 (Invariant)

In Line 6 of the relabel-to-front algorithm the following invariant holds.

- 1. The sequence L is topologically sorted w.r.t. the set of admissible edges; this means for an admissible edge (x, y) the node x appears before y in sequence L .*
- 2. No node before u in the list L is active.*

Proof:

► Initialization:

1. In the beginning s has label $n \geq 2$, and all other nodes have label 0. Hence, no edge is admissible, which means that any ordering L is permitted.
2. We start with u being the head of the list; hence no node before u can be active

► Maintenance:

1.
 - Pushes do not create any new admissible edges. Therefore, if `discharge()` does not relabel u , L is still topologically sorted.
 - After relabeling, u cannot have admissible incoming edges as such an edge (x, u) would have had a difference $\ell(x) - \ell(u) \geq 2$ before the re-labeling (such edges do not exist in the residual graph).
Hence, moving u to the front does not violate the sorting property for any edge; however it fixes this property for all admissible edges leaving u that were generated by the relabeling.

13.2 Relabel to Front

Proof:

► Maintenance:

2. If we do a relabel there is nothing to prove because the only node before u' (u in the next iteration) will be the current u ; the discharge(u) operation only terminates when u is not active anymore.

For the case that we do not relabel, observe that the only way a predecessor could be active is that we push flow to it via an admissible arc. However, all admissible arcs point to successors of u .

Note that the invariant means that for $u = \text{null}$ we have a preflow with a valid labelling that does not have active nodes. This means we have a maximum flow.

13.2 Relabel to Front

Lemma 38

There are at most $\mathcal{O}(n^3)$ calls to $\text{discharge}(u)$.

Every discharge operation without a relabel advances u (the current node within list L). Hence, if we have n discharge operations without a relabel we have $u = \text{null}$ and the algorithm terminates.

Therefore, the number of calls to discharge is at most $n(\#\text{relabels} + 1) = \mathcal{O}(n^3)$.

13.2 Relabel to Front

Lemma 39

The cost for all relabel-operations is only $\mathcal{O}(n^2)$.

A relabel-operation at a node is constant time (increasing the label and resetting *u .current-neighbour*). In total we have $\mathcal{O}(n^2)$ relabel-operations.

13.2 Relabel to Front

Note that by definition a saturating push operation ($\min\{c_f(e), f(u)\} = c_f(e)$) can at the same time be a non-saturating push operation ($\min\{c_f(e), f(u)\} = f(u)$).

Lemma 40

*The cost for all saturating push-operations that are **not** also non-saturating push-operations is only $\mathcal{O}(mn)$.*

Note that such a push-operation leaves the node u active but makes the edge e disappear from the residual graph. Therefore the push-operation is immediately followed by an increase of the pointer $u.current-neighbour$.

This pointer can traverse the neighbour-list at most $\mathcal{O}(n)$ times (upper bound on number of relabels) and the neighbour-list has only $degree(u) + 1$ many entries (+1 for null-entry).

13.2 Relabel to Front

Lemma 41

The cost for all non-saturating push-operations is only $\mathcal{O}(n^3)$.

A non-saturating push-operation takes constant time and ends the current call to `discharge()`. Hence, there are only $\mathcal{O}(n^3)$ such operations.

Theorem 42

The push-relabel algorithm with the rule relabel-to-front takes time $\mathcal{O}(n^3)$.

13.3 Highest Label

Algorithm 6 highest-label(G, s, t)

- 1: initialize preflow
- 2: **foreach** $u \in V \setminus \{s, t\}$ **do**
- 3: $u.current-neighbour \leftarrow u.neighbour-list-head$
- 4: **while** \exists active node u **do**
- 5: select active node u with highest label
- 6: discharge(u)

13.3 Highest Label

Lemma 43

When using highest label the number of non-saturating pushes is only $\mathcal{O}(n^3)$.

A push from a node on level ℓ can only “activate” nodes on levels strictly less than ℓ .

This means, after a non-saturating push from u a relabel is required to make u active again.

Hence, after n non-saturating pushes without an intermediate relabel there are no active nodes left.

Therefore, the number of non-saturating pushes is at most $n(\#relabels + 1) = \mathcal{O}(n^3)$.

13.3 Highest Label

Since a discharge-operation is terminated by a non-saturating push this gives an upper bound of $\mathcal{O}(n^3)$ on the number of discharge-operations.

The cost for relabels and saturating pushes can be estimated in exactly the same way as in the case of the generic push-relabel algorithm.

Question:

How do we find the next node for a discharge operation?

13.3 Highest Label

Maintain lists L_i , $i \in \{0, \dots, 2n\}$, where list L_i contains active nodes with label i (maintaining these lists induces only constant additional cost for every push-operation and for every relabel-operation).

After a discharge operation terminated for a node u with label k , traverse the lists L_k, L_{k-1}, \dots, L_0 , (in that order) until you find a non-empty list.

Unless the last (non-saturating) push was to s or t the list $k - 1$ must be non-empty (i.e., the search takes constant time).

13.3 Highest Label

Hence, the total time required for searching for active nodes is at most

$$\mathcal{O}(n^3) + n(\#non-saturating-pushes-to-s-or-t)$$

Lemma 44

The number of non-saturating pushes to s or t is at most $\mathcal{O}(n^2)$.

With this lemma we get

Theorem 45

The push-relabel algorithm with the rule highest-label takes time $\mathcal{O}(n^3)$.

13.3 Highest Label

Proof of the Lemma.

- ▶ We only show that the number of pushes to the source is at most $\mathcal{O}(n^2)$. A similar argument holds for the target.
- ▶ After a node v (which must have $\ell(v) = n + 1$) made a non-saturating push to the source there needs to be another node whose label is increased from $\leq n + 1$ to $n + 2$ before v can become active again.
- ▶ This happens for every push that v makes to the source. Since, every node can pass the threshold $n + 2$ at most once, v can make at most n pushes to the source.
- ▶ As this holds for every node the total number of pushes to the source is at most $\mathcal{O}(n^2)$.

Problem Definition:

$$\begin{aligned} \min \quad & \sum_e c(e)f(e) \\ \text{s.t.} \quad & \forall e \in E: 0 \leq f(e) \leq u(e) \\ & \forall v \in V: f(v) = b(v) \end{aligned}$$

- ▶ $G = (V, E)$ is a **directed graph**.
- ▶ $u : E \rightarrow \mathbb{R}_0^+ \cup \{\infty\}$ is the **capacity function**.
- ▶ $c : E \rightarrow \mathbb{R}$ is the **cost function**
(note that $c(e)$ may be negative).
- ▶ $b : V \rightarrow \mathbb{R}, \sum_{v \in V} b(v) = 0$ is a **demand function**.

Solve Maxflow Using Mincost Flow

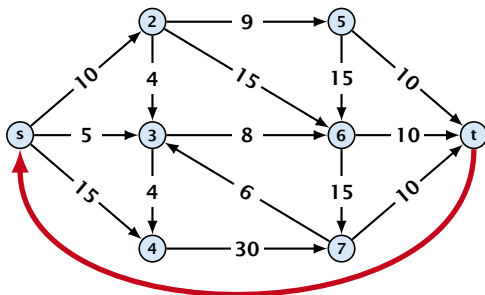

- ▶ Given a flow network for a standard maxflow problem.
- ▶ Set $b(v) = 0$ for every node. Keep the capacity function u for all edges. Set the cost $c(e)$ for every edge to 0.
- ▶ Add an edge from t to s with infinite capacity and cost -1 .
- ▶ Then, $\text{val}(f^*) = -\text{cost}(f_{\min})$, where f^* is a maxflow, and f_{\min} is a mincost-flow.

Solve Maxflow Using Mincost Flow

Solve decision version of maxflow:

- ▶ Given a flow network for a standard maxflow problem, and a value k .
- ▶ Set $b(v) = 0$ for every node apart from s or t . Set $b(s) = -k$ and $b(t) = k$.
- ▶ Set edge-costs to zero, and keep the capacities.
- ▶ There exists a maxflow of value at least k if and only if the mincost-flow problem is feasible.

Generalization

Our model:

$$\begin{aligned} \min \quad & \sum_e c(e)f(e) \\ \text{s.t.} \quad & \forall e \in E: 0 \leq f(e) \leq u(e) \\ & \forall v \in V: f(v) = b(v) \end{aligned}$$

where $b: V \rightarrow \mathbb{R}$, $\sum_v b(v) = 0$; $u: E \rightarrow \mathbb{R}_0^+ \cup \{\infty\}$; $c: E \rightarrow \mathbb{R}$;

A more general model?

$$\begin{aligned} \min \quad & \sum_e c(e)f(e) \\ \text{s.t.} \quad & \forall e \in E: \ell(e) \leq f(e) \leq u(e) \\ & \forall v \in V: a(v) \leq f(v) \leq b(v) \end{aligned}$$

where $a: V \rightarrow \mathbb{R}$, $b: V \rightarrow \mathbb{R}$; $\ell: E \rightarrow \mathbb{R} \cup \{-\infty\}$, $u: E \rightarrow \mathbb{R} \cup \{\infty\}$
 $c: E \rightarrow \mathbb{R}$;

Differences

- ▶ Flow along an edge e may have non-zero lower bound $\ell(e)$.
- ▶ Flow along e may have negative upper bound $u(e)$.
- ▶ The demand at a node v may have lower bound $a(v)$ and upper bound $b(v)$ instead of just lower bound = upper bound = $b(v)$.

Reduction I

$$\begin{aligned} \min \quad & \sum_e c(e)f(e) \\ \text{s.t.} \quad & \forall e \in E: \ell(e) \leq f(e) \leq u(e) \\ & \forall v \in V: a(v) \leq f(v) \leq b(v) \end{aligned}$$

We can assume that $a(v) = b(v)$:

Add new node r .

Add edge (r, v) for all $v \in V$.

Set $\ell(e) = c(e) = 0$ for these edges.

Set $u(e) = b(v) - a(v)$ for edge (r, v) .

Set $a(v) = b(v)$ for all $v \in V$.

Set $b(r) = -\sum_{v \in V} b(v)$.

$-\sum_v b(v)$ is negative; hence r is only sending flow.

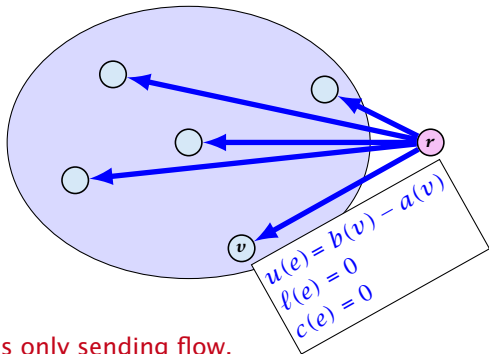

Reduction II

$$\begin{aligned} \min \quad & \sum_e c(e)f(e) \\ \text{s.t.} \quad & \forall e \in E: \ell(e) \leq f(e) \leq u(e) \\ & \forall v \in V: f(v) = b(v) \end{aligned}$$

We can assume that either $\ell(e) \neq -\infty$ or $u(e) \neq \infty$:

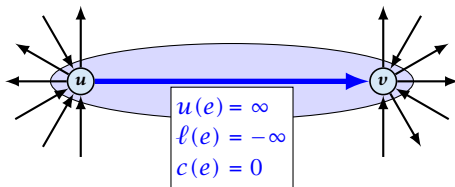

If $c(e) = 0$ we can contract the edge/identify nodes u and v .

If $c(e) \neq 0$ we can transform the graph so that $c(e) = 0$.

Reduction II

We can transform any network so that a particular edge has cost $c(e) = 0$:

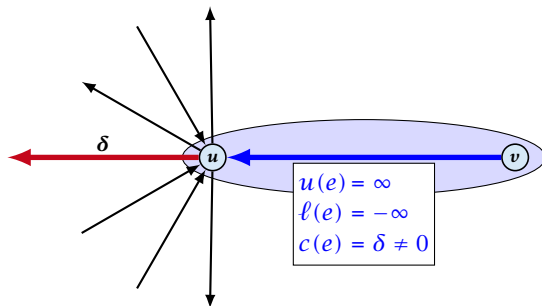

Additionally we set $b(u) = 0$.

Reduction III

$$\begin{aligned} \min \quad & \sum_e c(e)f(e) \\ \text{s.t.} \quad & \forall e \in E: \ell(e) \leq f(e) \leq u(e) \\ & \forall v \in V: f(v) = b(v) \end{aligned}$$

We can assume that $\ell(e) \neq -\infty$:

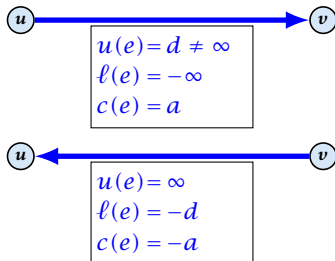

Replace the edge by an edge in opposite direction.

Reduction IV

$$\begin{aligned} \min \quad & \sum_e c(e)f(e) \\ \text{s.t.} \quad & \forall e \in E: \ell(e) \leq f(e) \leq u(e) \\ & \forall v \in V: f(v) = b(v) \end{aligned}$$

We can assume that $\ell(e) = 0$:

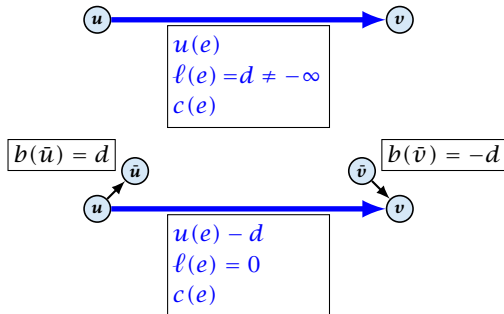

The added edges have infinite capacity and cost $c(e)/2$.

Caterer Problem

- ▶ She needs to supply r_i napkins on N successive days.
- ▶ She can buy new napkins at p cents each.
- ▶ She can launder them at a fast laundry that takes m days and cost f cents a napkin.
- ▶ She can use a slow laundry that takes $k > m$ days and costs s cents each.
- ▶ At the end of each day she should determine how many to send to each laundry and how many to buy in order to fulfill demand.
- ▶ Minimize cost.

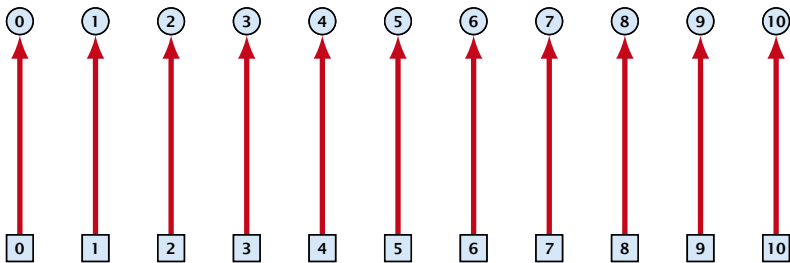

day edges:

upper bound: $u(e_i) = \infty$;

lower bound: $\ell(e_i) = r_i$;

cost: $c(e) = 0$

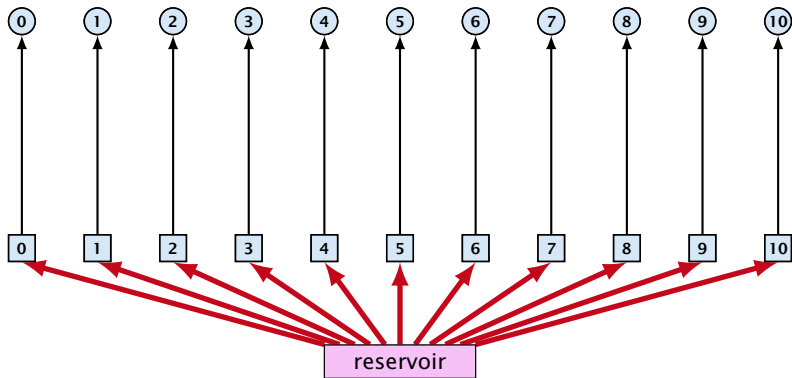

buy edges:

upper bound: $u(e_i) = \infty$;
lower bound: $\ell(e_i) = 0$;
cost: $c(e) = p$

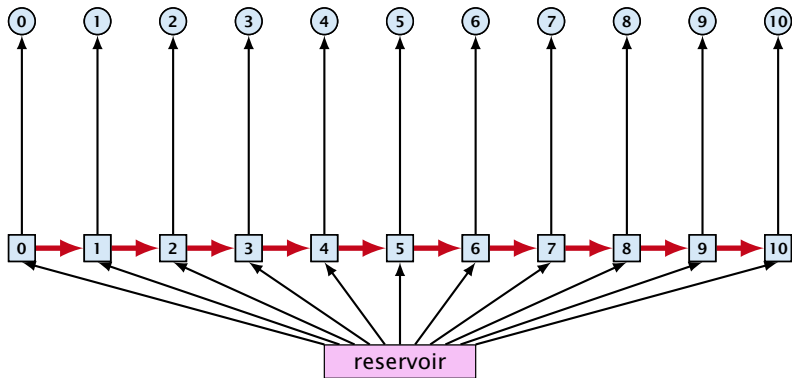

forward edges:

upper bound: $u(e_i) = \infty$;
lower bound: $\ell(e_i) = 0$;
cost: $c(e) = 0$

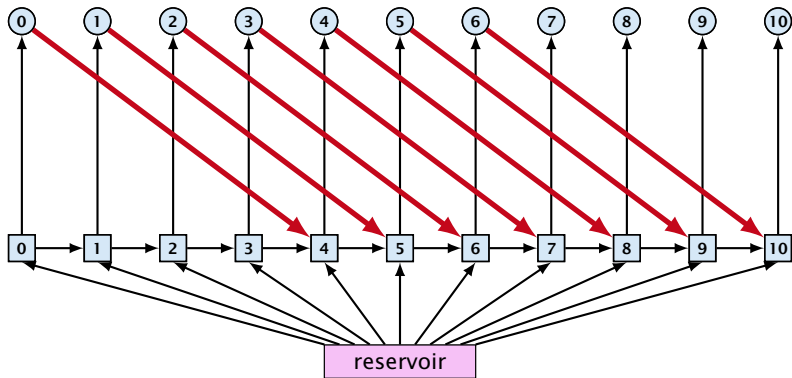

slow edges:

upper bound: $u(e_i) = \infty$;

lower bound: $\ell(e_i) = 0$;

cost: $c(e) = s$

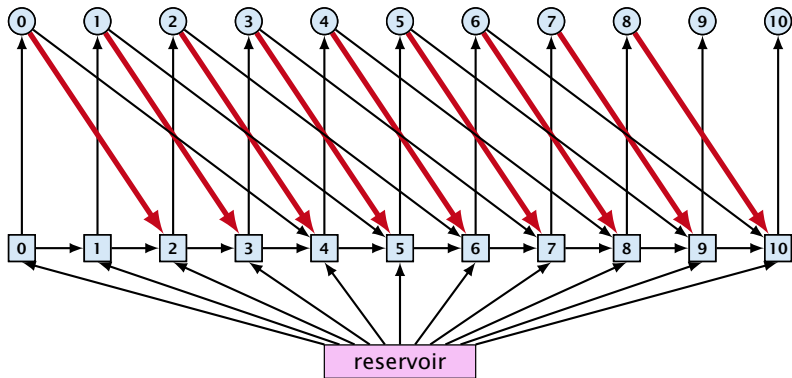

fast edges:

upper bound: $u(e_i) = \infty$;
 lower bound: $\ell(e_i) = 0$;
 cost: $c(e) = f$

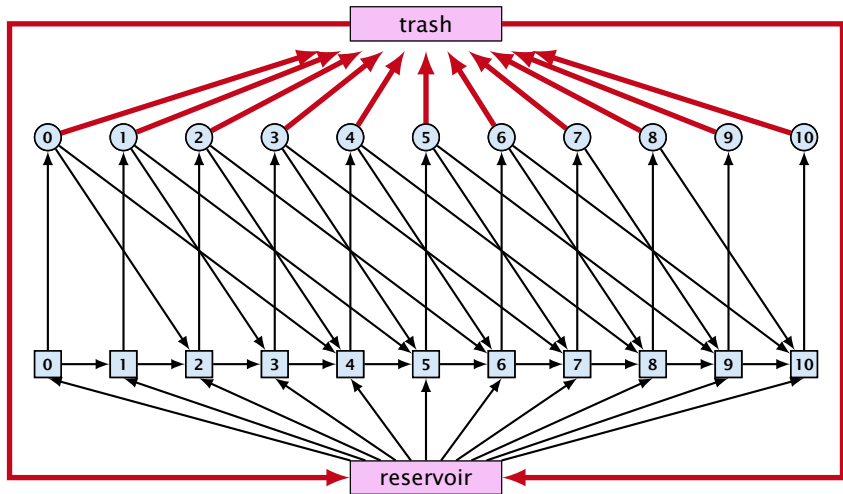

trash edges:

upper bound: $u(e_i) = \infty$;
 lower bound: $\ell(e_i) = 0$;
 cost: $c(e) = 0$

Residual Graph

Version A:

The residual graph G' for a mincost flow is just a copy of the graph G .

If we send $f(e)$ along an edge, the corresponding edge e' in the residual graph has its lower and upper bound changed to $l(e') = l(e) - f(e)$ and $u(e') = u(e) - f(e)$.

Version B:

The residual graph for a mincost flow is exactly defined as the residual graph for standard flows, with the only exception that one needs to define a cost for the residual edge.

For a flow of z from u to v the residual edge (v, u) has capacity z and a cost of $-c((u, v))$.

14 Mincost Flow

A **circulation** in a graph $G = (V, E)$ is a function $f : E \rightarrow \mathbb{R}^+$ that has an excess flow $f(v) = 0$ for every node $v \in V$.

A circulation is **feasible** if it fulfills capacity constraints, i.e., $f(e) \leq u(e)$ for every edge of G .

Lemma 46

A given flow is a mincost-flow if and only if the corresponding residual graph G_f does not have a feasible circulation of negative cost.

⇒ Suppose that g is a feasible circulation of negative cost in the residual graph.

Then $f + g$ is a feasible flow with cost $\text{cost}(f) + \text{cost}(g) < \text{cost}(f)$. Hence, f is not minimum cost.

⇐ Let f be a non-mincost flow, and let f^* be a min-cost flow. We need to show that the residual graph has a feasible circulation with negative cost.

Clearly $f^* - f$ is a circulation of negative cost. One can also easily see that it is feasible for the residual graph. (after sending $-f$ in the residual graph (pushing all flow back) we arrive at the original graph; for this f^* is clearly feasible)

For previous slide:

$g = f^* - f$ is obtained by computing $\Delta(e) = f^*(e) - f(e)$ for every edge $e = (u, v)$. If the result is positive set $g((u, v)) = \Delta(e)$ and $g((v, u)) = 0$. Otherwise set $g((u, v)) = 0$ and $g((v, u)) = -\Delta(e)$.

14 Mincost Flow

Lemma 47

A graph (without zero-capacity edges) has a feasible circulation of negative cost if and only if it has a negative cycle w.r.t. edge-weights $c : E \rightarrow \mathbb{R}$.

Proof.

- ▶ Suppose that we have a negative cost circulation.
- ▶ Find directed cycle only using edges that have non-zero flow.
- ▶ If this cycle has negative cost you are done.
- ▶ Otherwise send flow in opposite direction along the cycle until the bottleneck edge(s) does not carry any flow.
- ▶ You still have a circulation with negative cost.
- ▶ Repeat.

14 Mincost Flow

Algorithm 23 CycleCanceling($G = (V, E), c, u, b$)

- 1: establish a feasible flow f in G
- 2: **while** G_f contains negative cycle **do**
- 3: use Bellman-Ford to find a negative circuit Z
- 4: $\delta \leftarrow \min\{u_f(e) \mid e \in Z\}$
- 5: augment δ units along Z and update G_f

How do we find the initial feasible flow?

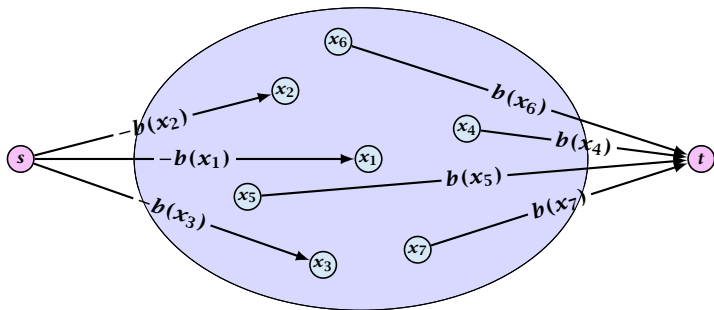

- ▶ Connect new node s to all nodes with negative $b(v)$ -value.
- ▶ Connect nodes with positive $b(v)$ -value to a new node t .
- ▶ There exist a feasible flow in the original graph iff in the resulting graph there exists an s - t flow of value

$$\sum_{v:b(v)<0} (-b(v)) = \sum_{v:b(v)>0} b(v) .$$

14 Mincost Flow

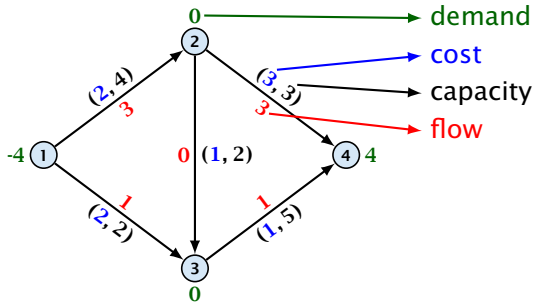

14 Mincost Flow

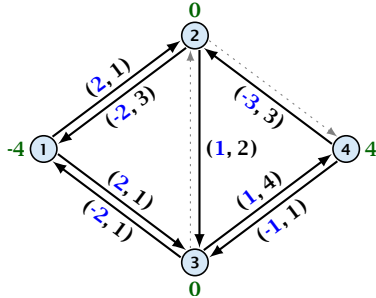

14 Mincost Flow

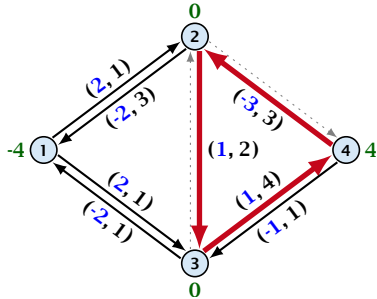

14 Mincost Flow

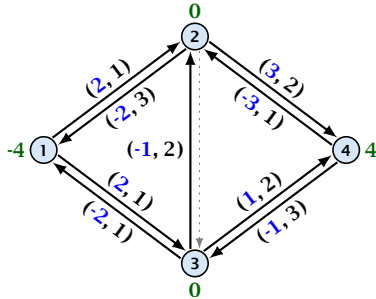

14 Mincost Flow

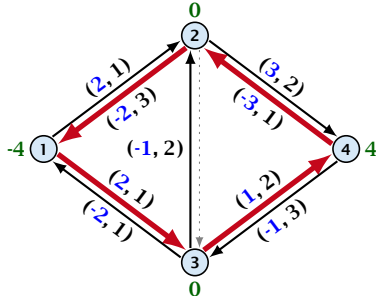

14 Mincost Flow

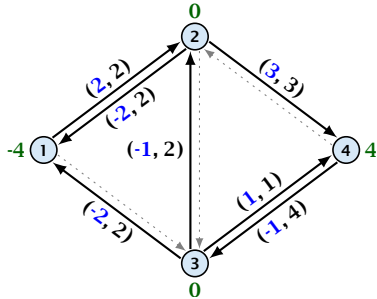

14 Mincost Flow

Lemma 48

The improving cycle algorithm runs in time $\mathcal{O}(nm^2CU)$, for integer capacities and costs, when for all edges e , $|c(e)| \leq C$ and $|u(e)| \leq U$.

- ▶ Running time of Bellman-Ford is $\mathcal{O}(mn)$.
- ▶ Pushing flow along the cycle can be done in time $\mathcal{O}(n)$.
- ▶ Each iteration decreases the total cost by at least 1.
- ▶ The true optimum cost must lie in the interval $[-mCU, \dots, +mCU]$.

Note that this lemma is weak since it does not allow for edges with infinite capacity.

14 Mincost Flow

A **general mincost flow problem** is of the following form:

$$\begin{aligned} \min \quad & \sum_e c(e) f(e) \\ \text{s.t.} \quad & \forall e \in E: \ell(e) \leq f(e) \leq u(e) \\ & \forall v \in V: a(v) \leq f(v) \leq b(v) \end{aligned}$$

where $a: V \rightarrow \mathbb{R}$, $b: V \rightarrow \mathbb{R}$; $\ell: E \rightarrow \mathbb{R} \cup \{-\infty\}$, $u: E \rightarrow \mathbb{R} \cup \{\infty\}$
 $c: E \rightarrow \mathbb{R}$;

Lemma 49 (without proof)

A general mincost flow problem can be solved in polynomial time.