

SS 2018/19

Efficient Algorithms and Data Structures II

Harald Räcke

Fakultät für Informatik
TU München

<http://www14.in.tum.de/lehre/2018SS/ea/>

Summer Term 2018/19

Part I

Organizational Matters

Part I

Organizational Matters

- ▶ Modul: IN2004
- ▶ Name: “Efficient Algorithms and Data Structures II”
“Effiziente Algorithmen und Datenstrukturen II”
- ▶ ECTS: 8 Credit points
- ▶ Lectures:
 - ▶ 4 SWS
 - Wed 12:15–13:45 (Room 00.13.009A)
 - Fri 10:15–11:45 (MS HS3)
- ▶ Webpage: <http://www14.in.tum.de/lehre/2018SS/ea/>

The Lecturer

- ▶ Harald Räcke
- ▶ Email: raecke@in.tum.de
- ▶ Room: 03.09.044
- ▶ Office hours: (per appointment)

Tutorials

- ▶ Tutor:
 - ▶ Richard Stotz
 - ▶ stotz@in.tum.de
 - ▶ Room: 03.09.057
 - ▶ per appointment
- ▶ Room: 03.11.018
- ▶ Time: **Mon 14:00-15:30**

Assessment

- ▶ In order to pass the module you need to pass an exam.
- ▶ Exam:
 - ▶ 2.5 hours
 - ▶ Date will be announced shortly.
 - ▶ There are no resources allowed, apart from a hand-written piece of paper (A4).
 - ▶ Answers should be given in English, but German is also accepted.

Assessment

- ▶ Assignment Sheets:
 - ▶ An assignment sheet is usually made available on Monday on the module webpage.
 - ▶ Solutions have to be handed in in the following week before the tutorial on Monday.
 - ▶ You can hand in your solutions by putting them in the right folder in front of room 03.09.020 or in person in the tutorial.
 - ▶ Solutions have to be given in English.
 - ▶ Solutions will be discussed in the subsequent tutorial.
 - ▶ The first one will be out on Monday, 16 April.



1 Contents

Part 1: Linear Programming

Part 2: Approximation Algorithms

2 Literatur

-  V. Chvatal:
Linear Programming,
Freeman, 1983
-  R. Seidel:
Skript Optimierung, 1996
-  D. Bertsimas and J.N. Tsitsiklis:
Introduction to Linear Optimization,
Athena Scientific, 1997
-  Vijay V. Vazirani:
Approximation Algorithms,
Springer 2001

-  David P. Williamson and David B. Shmoys:
The Design of Approximation Algorithms,
Cambridge University Press 2011
-  G. Ausiello, P. Crescenzi, G. Gambosi, V. Kann, A. Marchetti-Spaccamela, and M. Protasi:
Complexity and Approximation,
Springer, 1999

Part II

Linear Programming

Brewery Problem

Brewery brews ale and beer.

- ▶ Production limited by supply of corn, hops and barley malt
- ▶ Recipes for ale and beer require different amounts of resources

	<i>Corn (kg)</i>	<i>Hops (kg)</i>	<i>Malt (kg)</i>	<i>Profit (€)</i>
ale (barrel)	5	4	35	13
beer (barrel)	15	4	20	23
supply	480	160	1190	

Brewery Problem

	Corn (kg)	Hops (kg)	Malt (kg)	Profit (€)
ale (barrel)	5	4	35	13
beer (barrel)	15	4	20	23
supply	480	160	1190	

How can brewer maximize profits?

- ▶ only brew ale: 34 barrels of ale \Rightarrow 442 €
- ▶ only brew beer: 32 barrels of beer \Rightarrow 736 €
- ▶ 7.5 barrels ale, 29.5 barrels beer \Rightarrow 776 €
- ▶ 12 barrels ale, 28 barrels beer \Rightarrow 800 €

Brewery Problem

Linear Program

- ▶ Introduce variables a and b that define how much ale and beer to produce.
- ▶ Choose the variables in such a way that the objective function (profit) is maximized.
- ▶ Make sure that no constraints (due to limited supply) are violated.

$$\begin{aligned} \max \quad & 13a + 23b \\ \text{s.t.} \quad & 5a + 15b \leq 480 \\ & 4a + 4b \leq 160 \\ & 35a + 20b \leq 1190 \\ & a, b \geq 0 \end{aligned}$$

Standard Form LPs

LP in standard form:

- ▶ input: numbers a_{ij} , c_j , b_i
- ▶ output: numbers x_j
- ▶ n = #decision variables, m = #constraints
- ▶ maximize linear objective function subject to linear (in)equalities

$$\begin{aligned} \max \quad & \sum_{j=1}^n c_j x_j \\ \text{s.t.} \quad & \sum_{j=1}^n a_{ij} x_j = b_i \quad 1 \leq i \leq m \\ & x_j \geq 0 \quad 1 \leq j \leq n \end{aligned}$$

$$\begin{aligned} \max \quad & c^T x \\ \text{s.t.} \quad & Ax = b \\ & x \geq 0 \end{aligned}$$

Standard Form LPs

Original LP

$$\begin{aligned} \max \quad & 13a + 23b \\ \text{s.t.} \quad & 5a + 15b \leq 480 \\ & 4a + 4b \leq 160 \\ & 35a + 20b \leq 1190 \\ & a, b \geq 0 \end{aligned}$$

Standard Form

Add a slack variable to every constraint.

$$\begin{aligned} \max \quad & 13a + 23b \\ \text{s.t.} \quad & 5a + 15b + s_c = 480 \\ & 4a + 4b + s_h = 160 \\ & 35a + 20b + s_m = 1190 \\ & a, b, s_c, s_h, s_m \geq 0 \end{aligned}$$

Standard Form LPs

There are different standard forms:

$$\begin{array}{ll} \text{standard form} \\ \max & c^T x \\ \text{s.t.} & Ax = b \\ & x \geq 0 \end{array}$$

$$\begin{array}{ll} \min & c^T x \\ \text{s.t.} & Ax = b \\ & x \geq 0 \end{array}$$

$$\begin{array}{ll} \text{standard} \\ \text{maximization form} \\ \max & c^T x \\ \text{s.t.} & Ax \leq b \\ & x \geq 0 \end{array}$$

$$\begin{array}{ll} \text{standard} \\ \text{minimization form} \\ \min & c^T x \\ \text{s.t.} & Ax \geq b \\ & x \geq 0 \end{array}$$

Standard Form LPs

It is easy to transform variants of LPs into (any) standard form:

- ▶ **less or equal to equality:**

$$a - 3b + 5c \leq 12 \Rightarrow \begin{array}{l} a - 3b + 5c + s = 12 \\ s \geq 0 \end{array}$$

- ▶ **greater or equal to equality:**

$$a - 3b + 5c \geq 12 \Rightarrow \begin{array}{l} a - 3b + 5c - s = 12 \\ s \geq 0 \end{array}$$

- ▶ **min to max:**

$$\min a - 3b + 5c \Rightarrow \max -a + 3b - 5c$$

Standard Form LPs

It is easy to transform variants of LPs into (any) standard form:

- ▶ **equality to less or equal:**

$$a - 3b + 5c = 12 \Rightarrow \begin{array}{l} a - 3b + 5c \leq 12 \\ -a + 3b - 5c \leq -12 \end{array}$$

- ▶ **equality to greater or equal:**

$$a - 3b + 5c = 12 \Rightarrow \begin{array}{l} a - 3b + 5c \geq 12 \\ -a + 3b - 5c \geq -12 \end{array}$$

- ▶ **unrestricted to nonnegative:**

$$x \text{ unrestricted} \Rightarrow x = x^+ - x^-, x^+ \geq 0, x^- \geq 0$$

Standard Form LPs

Observations:

- ▶ a linear program does not contain x^2 , $\cos(x)$, etc.
- ▶ transformations between standard forms can be done efficiently and only change the size of the LP by a small constant factor
- ▶ for the standard minimization or maximization LPs we could include the nonnegativity constraints into the set of ordinary constraints; this is of course not possible for the standard form

Fundamental Questions

Definition 1 (Linear Programming Problem (LP))

Let $A \in \mathbb{Q}^{m \times n}$, $b \in \mathbb{Q}^m$, $c \in \mathbb{Q}^n$, $\alpha \in \mathbb{Q}$. Does there exist $x \in \mathbb{Q}^n$ s.t. $Ax = b$, $x \geq 0$, $c^T x \geq \alpha$?

Questions:

- ▶ Is LP in NP?
- ▶ Is LP in co-NP?
- ▶ Is LP in P?

Input size:

- ▶ n number of variables, m constraints, L number of bits to encode the input

Geometry of Linear Programming

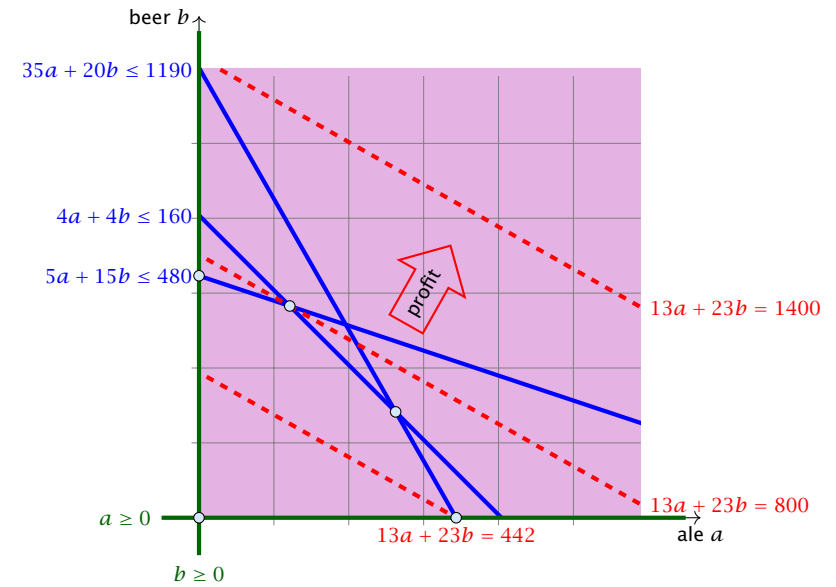

Geometry of Linear Programming

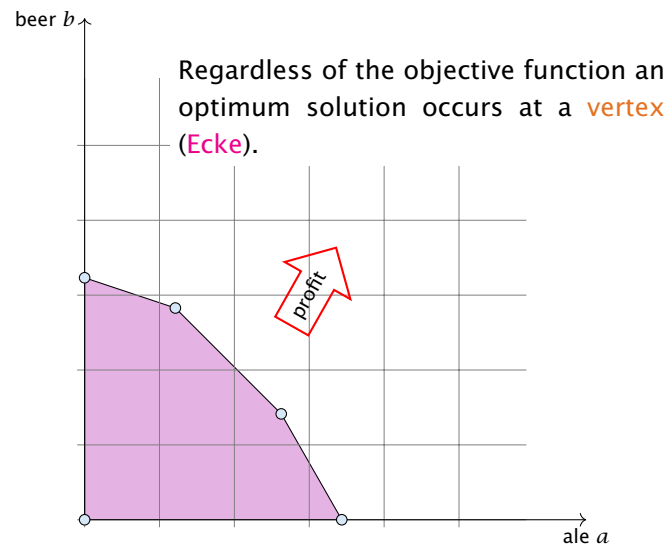

Definitions

Let for a Linear Program in standard form $P = \{x \mid Ax = b, x \geq 0\}$.

- ▶ P is called the **feasible region (Lösungsraum)** of the LP.
- ▶ A point $x \in P$ is called a **feasible point (gultige Losung)**.
- ▶ If $P \neq \emptyset$ then the LP is called **feasible (erfullbar)**. Otherwise, it is called **infeasible (unerfullbar)**.
- ▶ An LP is **bounded (beschrankt)** if it is feasible and
 - ▶ $c^T x < \infty$ for all $x \in P$ (for maximization problems)
 - ▶ $c^T x > -\infty$ for all $x \in P$ (for minimization problems)

Definition 2

Given vectors/points $x_1, \dots, x_k \in \mathbb{R}^n$, $\sum \lambda_i x_i$ is called

- ▶ **linear combination** if $\lambda_i \in \mathbb{R}$.
- ▶ **affine combination** if $\lambda_i \in \mathbb{R}$ and $\sum_i \lambda_i = 1$.
- ▶ **convex combination** if $\lambda_i \in \mathbb{R}$ and $\sum_i \lambda_i = 1$ and $\lambda_i \geq 0$.
- ▶ **conic combination** if $\lambda_i \in \mathbb{R}$ and $\lambda_i \geq 0$.

Note that a combination involves only finitely many vectors.

Definition 3

A set $X \subseteq \mathbb{R}^n$ is called

- ▶ a **linear subspace** if it is closed under linear combinations.
- ▶ an **affine subspace** if it is closed under affine combinations.
- ▶ **convex** if it is closed under convex combinations.
- ▶ a **convex cone** if it is closed under conic combinations.

Note that an affine subspace is **not** a vector space

Definition 4

Given a set $X \subseteq \mathbb{R}^n$.

- ▶ **span**(X) is the set of all linear combinations of X
(**linear hull**, **span**)
- ▶ **aff**(X) is the set of all affine combinations of X
(**affine hull**)
- ▶ **conv**(X) is the set of all convex combinations of X
(**convex hull**)
- ▶ **cone**(X) is the set of all conic combinations of X
(**conic hull**)

Definition 5

A function $f : \mathbb{R}^n \rightarrow \mathbb{R}$ is **convex** if for $x, y \in \mathbb{R}^n$ and $\lambda \in [0, 1]$ we have

$$f(\lambda x + (1 - \lambda)y) \leq \lambda f(x) + (1 - \lambda)f(y)$$

Lemma 6

If $P \subseteq \mathbb{R}^n$, and $f : \mathbb{R}^n \rightarrow \mathbb{R}$ convex then also

$$Q = \{x \in P \mid f(x) \leq t\}$$

Dimensions

Definition 7

The **dimension** $\dim(A)$ of an affine subspace $A \subseteq \mathbb{R}^n$ is the dimension of the vector space $\{x - a \mid x \in A\}$, where $a \in A$.

Definition 8

The **dimension** $\dim(X)$ of a convex set $X \subseteq \mathbb{R}^n$ is the dimension of its affine hull $\text{aff}(X)$.

Definition 9

A set $H \subseteq \mathbb{R}^n$ is a **hyperplane** if $H = \{x \mid a^T x = b\}$, for $a \neq 0$.

Definition 10

A set $H' \subseteq \mathbb{R}^n$ is a (closed) **halfspace** if $H = \{x \mid a^T x \leq b\}$, for $a \neq 0$.

Definitions

Definition 11

A **polytop** is a set $P \subseteq \mathbb{R}^n$ that is the convex hull of a **finite** set of points, i.e., $P = \text{conv}(X)$ where $|X| = c$.

Definitions

Definition 12

A **polyhedron** is a set $P \subseteq \mathbb{R}^n$ that can be represented as the intersection of **finitely** many half-spaces $\{H(a_1, b_1), \dots, H(a_m, b_m)\}$, where

$$H(a_i, b_i) = \{x \in \mathbb{R}^n \mid a_i x \leq b_i\} .$$

Definition 13

A polyhedron P is **bounded** if there exists B s.t. $\|x\|_2 \leq B$ for all $x \in P$.

Definitions

Theorem 14

P is a bounded polyhedron iff P is a polytop.

Definition 15

Let $P \subseteq \mathbb{R}^n$, $a \in \mathbb{R}^n$ and $b \in \mathbb{R}$. The hyperplane

$$H(a, b) = \{x \in \mathbb{R}^n \mid a^T x = b\}$$

is a supporting hyperplane of P if $\max\{a^T x \mid x \in P\} = b$.

Definition 16

Let $P \subseteq \mathbb{R}^n$. F is a face of P if $F = P$ or $F = P \cap H$ for some supporting hyperplane H .

Definition 17

Let $P \subseteq \mathbb{R}^n$.

- ▶ a face v is a vertex of P if $\{v\}$ is a face of P .
- ▶ a face e is an edge of P if e is a face and $\dim(e) = 1$.
- ▶ a face F is a facet of P if F is a face and $\dim(F) = \dim(P) - 1$.

Equivalent definition for vertex:

Definition 18

Given polyhedron P . A point $x \in P$ is a vertex if $\exists c \in \mathbb{R}^n$ such that $c^T y < c^T x$, for all $y \in P$, $y \neq x$.

Definition 19

Given polyhedron P . A point $x \in P$ is an extreme point if $\nexists a, b \neq x$, $a, b \in P$, with $\lambda a + (1 - \lambda)b = x$ for $\lambda \in [0, 1]$.

Lemma 20

A vertex is also an extreme point.

Observation

The feasible region of an LP is a Polyhedron.

Convex Sets

Theorem 21

If there exists an optimal solution to an LP (in standard form) then there exists an optimum solution that is an extreme point.

Proof

- ▶ suppose x is optimal solution that is not extreme point
- ▶ there exists direction $d \neq 0$ such that $x \pm d \in P$
- ▶ $Ad = 0$ because $A(x \pm d) = b$
- ▶ Wlog. assume $c^T d \geq 0$ (by taking either d or $-d$)
- ▶ Consider $x + \lambda d, \lambda > 0$

Convex Sets

Case 1. [$\exists j$ s.t. $d_j < 0$]

- ▶ increase λ to λ' until first component of $x + \lambda d$ hits 0
- ▶ $x + \lambda' d$ is feasible. Since $A(x + \lambda' d) = b$ and $x + \lambda' d \geq 0$
- ▶ $x + \lambda' d$ has one more zero-component ($d_k = 0$ for $x_k = 0$ as $x \pm d \in P$)
- ▶ $c^T x' = c^T(x + \lambda' d) = c^T x + \lambda' c^T d \geq c^T x$

Case 2. [$d_j \geq 0$ for all j and $c^T d > 0$]

- ▶ $x + \lambda d$ is feasible for all $\lambda \geq 0$ since $A(x + \lambda d) = b$ and $x + \lambda d \geq x \geq 0$
- ▶ as $\lambda \rightarrow \infty, c^T(x + \lambda d) \rightarrow \infty$ as $c^T d > 0$

Algebraic View

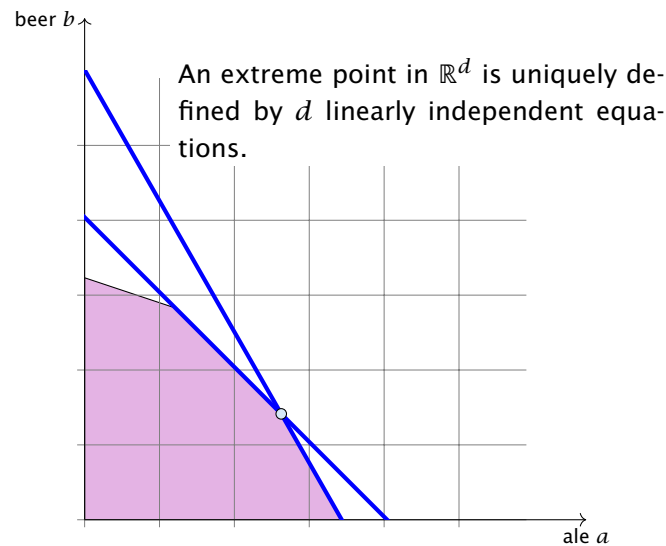

Notation

Suppose $B \subseteq \{1 \dots n\}$ is a set of column-indices. Define A_B as the subset of columns of A indexed by B .

Theorem 22

Let $P = \{x \mid Ax = b, x \geq 0\}$. For $x \in P$, define $B = \{j \mid x_j > 0\}$. Then x is extreme point iff A_B has linearly independent columns.

Theorem 22

Let $P = \{x \mid Ax = b, x \geq 0\}$. For $x \in P$, define $B = \{j \mid x_j > 0\}$. Then x is extreme point iff A_B has linearly independent columns.

Proof (\Leftarrow)

- ▶ assume x is not extreme point
- ▶ there exists direction d s.t. $x \pm d \in P$
- ▶ $Ad = 0$ because $A(x \pm d) = b$
- ▶ define $B' = \{j \mid d_j \neq 0\}$
- ▶ $A_{B'}$ has linearly dependent columns as $Ad = 0$
- ▶ $d_j = 0$ for all j with $x_j = 0$ as $x \pm d \geq 0$
- ▶ Hence, $B' \subseteq B$, $A_{B'}$ is sub-matrix of A_B

Theorem 22

Let $P = \{x \mid Ax = b, x \geq 0\}$. For $x \in P$, define $B = \{j \mid x_j > 0\}$. Then x is extreme point iff A_B has linearly independent columns.

Proof (\Rightarrow)

- ▶ assume A_B has linearly dependent columns
- ▶ there exists $d \neq 0$ such that $A_B d = 0$
- ▶ extend d to \mathbb{R}^n by adding 0-components
- ▶ now, $Ad = 0$ and $d_j = 0$ whenever $x_j = 0$
- ▶ for sufficiently small λ we have $x \pm \lambda d \in P$
- ▶ hence, x is not extreme point

Theorem 23

Let $P = \{x \mid Ax = b, x \geq 0\}$. For $x \in P$, define $B = \{j \mid x_j > 0\}$. If A_B has linearly independent columns then x is a vertex of P .

- ▶ define $c_j = \begin{cases} 0 & j \in B \\ -1 & j \notin B \end{cases}$
- ▶ then $c^T x = 0$ and $c^T y \leq 0$ for $y \in P$
- ▶ assume $c^T y = 0$; then $y_j = 0$ for all $j \notin B$
- ▶ $b = Ay = A_B y_B = Ax = A_B x_B$ gives that $A_B(x_B - y_B) = 0$;
- ▶ this means that $x_B = y_B$ since A_B has linearly independent columns
- ▶ we get $y = x$
- ▶ hence, x is a vertex of P

Observation

For an LP we can assume wlog. that the matrix A has full row-rank. This means $\text{rank}(A) = m$.

- ▶ assume that $\text{rank}(A) < m$
- ▶ assume wlog. that the first row A_1 lies in the span of the other rows A_2, \dots, A_m ; this means

$$A_1 = \sum_{i=2}^m \lambda_i \cdot A_i, \text{ for suitable } \lambda_i$$

- C1** if now $b_1 = \sum_{i=2}^m \lambda_i \cdot b_i$ then for all x with $A_i x = b_i$ we also have $A_1 x = b_1$; hence the first constraint is superfluous
- C2** if $b_1 \neq \sum_{i=2}^m \lambda_i \cdot b_i$ then the LP is infeasible, since for all x that fulfill constraints A_2, \dots, A_m we have

$$A_1 x = \sum_{i=2}^m \lambda_i \cdot A_i x = \sum_{i=2}^m \lambda_i \cdot b_i \neq b_1$$

From now on we will always assume that the constraint matrix of a standard form LP has full row rank.

Theorem 24

Given $P = \{x \mid Ax = b, x \geq 0\}$. x is extreme point iff there exists $B \subseteq \{1, \dots, n\}$ with $|B| = m$ and

- ▶ A_B is non-singular
- ▶ $x_B = A_B^{-1}b \geq 0$
- ▶ $x_N = 0$

where $N = \{1, \dots, n\} \setminus B$.

Proof

Take $B = \{j \mid x_j > 0\}$ and augment with linearly independent columns until $|B| = m$; always possible since $\text{rank}(A) = m$.

Basic Feasible Solutions

$x \in \mathbb{R}^n$ is called **basic solution (Basislösung)** if $Ax = b$ and $\text{rank}(A_J) = |J|$ where $J = \{j \mid x_j \neq 0\}$;

x is a **basic feasible solution (gültige Basislösung)** if in addition $x \geq 0$.

A **basis (Basis)** is an index set $B \subseteq \{1, \dots, n\}$ with $\text{rank}(A_B) = m$ and $|B| = m$.

$x \in \mathbb{R}^n$ with $A_B x_B = b$ and $x_j = 0$ for all $j \notin B$ is the **basic solution associated to basis B (die zu B assoziierte Basislösung)**

Basic Feasible Solutions

A BFS fulfills the m equality constraints.

In addition, at least $n - m$ of the x_i 's are zero. The corresponding non-negativity constraint is fulfilled with equality.

Fact:

In a BFS at least n constraints are fulfilled with equality.

Basic Feasible Solutions

Definition 25

For a general LP ($\max\{c^T x \mid Ax \leq b\}$) with n variables a point x is a **basic feasible solution** if x is feasible and there exist n (linearly independent) constraints that are tight.

Algebraic View

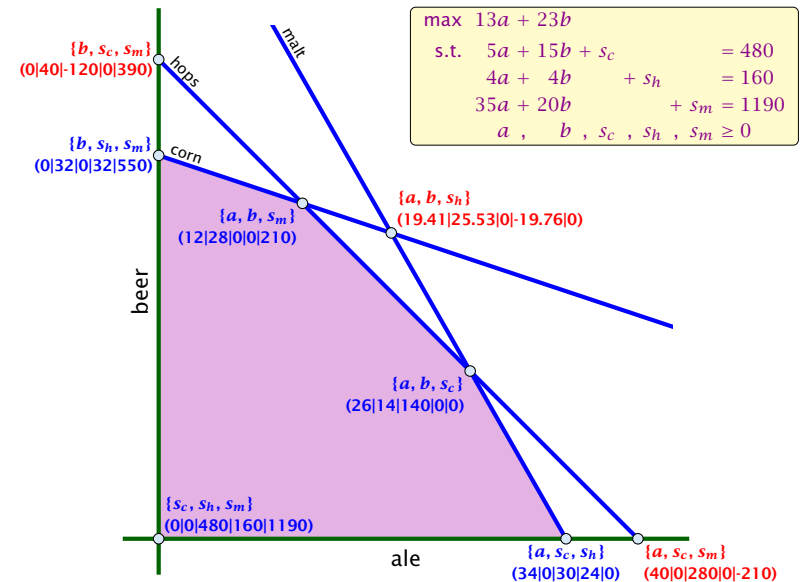

Fundamental Questions

Linear Programming Problem (LP)

Let $A \in \mathbb{Q}^{m \times n}$, $b \in \mathbb{Q}^m$, $c \in \mathbb{Q}^n$, $\alpha \in \mathbb{Q}$. Does there exist $x \in \mathbb{Q}^n$ s.t. $Ax = b$, $x \geq 0$, $c^T x \geq \alpha$?

Questions:

- ▶ Is LP in NP? yes!
- ▶ Is LP in co-NP?
- ▶ Is LP in P?

Proof:

- ▶ Given a basis B we can compute the associated basis solution by calculating $A_B^{-1}b$ in polynomial time; then we can also compute the profit.

Observation

We can compute an optimal solution to a linear program in time $\mathcal{O}\left(\binom{n}{m} \cdot \text{poly}(n, m)\right)$.

- ▶ there are only $\binom{n}{m}$ different bases.
- ▶ compute the profit of each of them and take the maximum

What happens if LP is unbounded?

4 Simplex Algorithm

Enumerating all basic feasible solutions (BFS), in order to find the optimum is slow.

Simplex Algorithm [George Dantzig 1947]

Move from BFS to **adjacent** BFS, without decreasing objective function.

Two BFSs are called **adjacent** if the bases just differ in one variable.

4 Simplex Algorithm

$$\begin{array}{rcl} \max & 13a + 23b & \\ \text{s.t.} & 5a + 15b + s_c & = 480 \\ & 4a + 4b + s_h & = 160 \\ & 35a + 20b + s_m & = 1190 \\ & a, b, s_c, s_h, s_m & \geq 0 \end{array}$$

$$\begin{array}{rcl} \max Z & & - Z = 0 \\ 13a + 23b & & - Z = 0 \\ 5a + 15b + s_c & & = 480 \\ 4a + 4b + s_h & & = 160 \\ 35a + 20b + s_m & & = 1190 \\ a, b, s_c, s_h, s_m & & \geq 0 \end{array}$$

$$\begin{array}{l} \text{basis} = \{s_c, s_h, s_m\} \\ a = b = 0 \\ Z = 0 \\ s_c = 480 \\ s_h = 160 \\ s_m = 1190 \end{array}$$

Pivoting Step

$$\begin{array}{rcl} \max Z & & - Z = 0 \\ 13a + 23b & & - Z = 0 \\ 5a + 15b + s_c & & = 480 \\ 4a + 4b + s_h & & = 160 \\ 35a + 20b + s_m & & = 1190 \\ a, b, s_c, s_h, s_m & & \geq 0 \end{array}$$

$$\begin{array}{l} \text{basis} = \{s_c, s_h, s_m\} \\ a = b = 0 \\ Z = 0 \\ s_c = 480 \\ s_h = 160 \\ s_m = 1190 \end{array}$$

- ▶ choose variable to bring into the basis
- ▶ chosen variable should have positive coefficient in objective function
- ▶ apply **min-ratio** test to find out by how much the variable can be increased
- ▶ pivot on row found by min-ratio test
- ▶ the existing basis variable in this row leaves the basis

$$\begin{array}{rcl} \max Z & & - Z = 0 \\ 13a + 23b & & - Z = 0 \\ 5a + 15b + s_c & & = 480 \\ 4a + 4b + s_h & & = 160 \\ 35a + 20b + s_m & & = 1190 \\ a, b, s_c, s_h, s_m & & \geq 0 \end{array}$$

$$\begin{array}{l} \text{basis} = \{s_c, s_h, s_m\} \\ a = b = 0 \\ Z = 0 \\ s_c = 480 \\ s_h = 160 \\ s_m = 1190 \end{array}$$

- ▶ Choose variable with coefficient > 0 as **entering variable**.
- ▶ If we keep $a = 0$ and increase b from 0 to $\theta > 0$ s.t. all constraints ($Ax = b, x \geq 0$) are still fulfilled the objective value Z will strictly increase.
- ▶ For maintaining $Ax = b$ we need e.g. to set $s_c = 480 - 15\theta$.
- ▶ Choosing $\theta = \min\{480/15, 160/4, 1190/20\}$ ensures that in the new solution one current basic variable becomes 0 , and no variable goes negative.
- ▶ The basic variable in the row that gives $\min\{480/15, 160/4, 1190/20\}$ becomes the **leaving variable**.

$$\begin{array}{rcl}
 \max Z & & \\
 13a + 23b & - Z = & 0 \\
 5a + 15b + s_c & = & 480 \\
 4a + 4b + s_h & = & 160 \\
 35a + 20b + s_m & = & 1190 \\
 a, b, s_c, s_h, s_m & \geq & 0
 \end{array}$$

$$\begin{array}{l}
 \text{basis} = \{s_c, s_h, s_m\} \\
 a = b = 0 \\
 Z = 0 \\
 s_c = 480 \\
 s_h = 160 \\
 s_m = 1190
 \end{array}$$

Substitute $b = \frac{1}{15}(480 - 5a - s_c)$.

$$\begin{array}{rcl}
 \max Z & & \\
 \frac{16}{3}a - \frac{23}{15}s_c & - Z = & -736 \\
 \frac{1}{3}a + b + \frac{1}{15}s_c & = & 32 \\
 \frac{8}{3}a - \frac{4}{15}s_c + s_h & = & 32 \\
 \frac{85}{3}a - \frac{4}{3}s_c + s_m & = & 550 \\
 a, b, s_c, s_h, s_m & \geq & 0
 \end{array}$$

$$\begin{array}{l}
 \text{basis} = \{b, s_h, s_m\} \\
 a = s_c = 0 \\
 Z = 736 \\
 b = 32 \\
 s_h = 32 \\
 s_m = 550
 \end{array}$$

$$\begin{array}{rcl}
 \max Z & & \\
 \frac{16}{3}a - \frac{23}{15}s_c & - Z = & -736 \\
 \frac{1}{3}a + b + \frac{1}{15}s_c & = & 32 \\
 \frac{8}{3}a - \frac{4}{15}s_c + s_h & = & 32 \\
 \frac{85}{3}a - \frac{4}{3}s_c + s_m & = & 550 \\
 a, b, s_c, s_h, s_m & \geq & 0
 \end{array}$$

$$\begin{array}{l}
 \text{basis} = \{b, s_h, s_m\} \\
 a = s_c = 0 \\
 Z = 736 \\
 b = 32 \\
 s_h = 32 \\
 s_m = 550
 \end{array}$$

Choose variable a to bring into basis.

Computing $\min\{3 \cdot 32, 3 \cdot 32/8, 3 \cdot 550/85\}$ means pivot on line 2.

Substitute $a = \frac{3}{8}(32 + \frac{4}{15}s_c - s_h)$.

$$\begin{array}{rcl}
 \max Z & & \\
 -s_c - 2s_h & - Z = & -800 \\
 b + \frac{1}{10}s_c - \frac{1}{8}s_h & = & 28 \\
 a - \frac{1}{10}s_c + \frac{3}{8}s_h & = & 12 \\
 \frac{3}{2}s_c - \frac{85}{8}s_h + s_m & = & 210 \\
 a, b, s_c, s_h, s_m & \geq & 0
 \end{array}$$

$$\begin{array}{l}
 \text{basis} = \{a, b, s_m\} \\
 s_c = s_h = 0 \\
 Z = 800 \\
 b = 28 \\
 a = 12 \\
 s_m = 210
 \end{array}$$

4 Simplex Algorithm

Pivoting stops when all coefficients in the objective function are non-positive.

Solution is optimal:

- ▶ any feasible solution satisfies all equations in the tableaux
- ▶ in particular: $Z = 800 - s_c - 2s_h, s_c \geq 0, s_h \geq 0$
- ▶ hence optimum solution value is at most 800
- ▶ the current solution has value 800

Matrix View

Let our linear program be

$$\begin{array}{l}
 c_B^T x_B + c_N^T x_N = Z \\
 A_B x_B + A_N x_N = b \\
 x_B, x_N \geq 0
 \end{array}$$

The simplex tableaux for basis B is

$$\begin{array}{l}
 (c_N^T - c_B^T A_B^{-1} A_N) x_N = Z - c_B^T A_B^{-1} b \\
 I x_B + A_B^{-1} A_N x_N = A_B^{-1} b \\
 x_B, x_N \geq 0
 \end{array}$$

The BFS is given by $x_N = 0, x_B = A_B^{-1} b$.

If $(c_N^T - c_B^T A_B^{-1} A_N) \leq 0$ we know that we have an optimum solution.

Geometric View of Pivoting

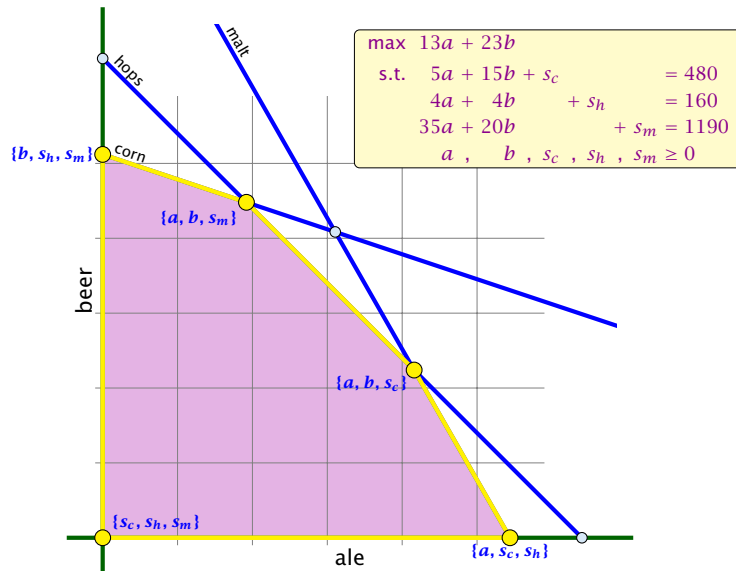

Algebraic Definition of Pivoting

- ▶ Given basis B with BFS x^* .
- ▶ Choose index $j \notin B$ in order to increase x_j^* from 0 to $\theta > 0$.
 - ▶ Other non-basis variables should stay at 0 .
 - ▶ Basis variables change to maintain feasibility.
- ▶ Go from x^* to $x^* + \theta \cdot d$.

Requirements for d :

- ▶ $d_j = 1$ (normalization)
- ▶ $d_\ell = 0, \ell \notin B, \ell \neq j$
- ▶ $A(x^* + \theta d) = b$ must hold. Hence $Ad = 0$.
- ▶ Altogether: $A_B d_B + A_{*j} = Ad = 0$, which gives $d_B = -A_B^{-1} A_{*j}$.

Algebraic Definition of Pivoting

Definition 26 (j -th basis direction)

Let B be a basis, and let $j \notin B$. The vector d with $d_j = 1$ and $d_\ell = 0, \ell \notin B, \ell \neq j$ and $d_B = -A_B^{-1} A_{*j}$ is called the j -th basis direction for B .

Going from x^* to $x^* + \theta \cdot d$ the objective function changes by

$$\theta \cdot c^T d = \theta(c_j - c_B^T A_B^{-1} A_{*j})$$

Algebraic Definition of Pivoting

Definition 27 (Reduced Cost)

For a basis B the value

$$\tilde{c}_j = c_j - c_B^T A_B^{-1} A_{*j}$$

is called the **reduced cost** for variable x_j .

Note that this is defined for every j . If $j \in B$ then the above term is 0 .

Algebraic Definition of Pivoting

Let our linear program be

$$\begin{aligned}c_B^T x_B + c_N^T x_N &= Z \\A_B x_B + A_N x_N &= b \\x_B, x_N &\geq 0\end{aligned}$$

The simplex tableaux for basis B is

$$\begin{aligned}(c_N^T - c_B^T A_B^{-1} A_N) x_N &= Z - c_B^T A_B^{-1} b \\I x_B + A_B^{-1} A_N x_N &= A_B^{-1} b \\x_B, x_N &\geq 0\end{aligned}$$

The BFS is given by $x_N = 0, x_B = A_B^{-1} b$.

If $(c_N^T - c_B^T A_B^{-1} A_N) \leq 0$ we know that we have an optimum solution.

4 Simplex Algorithm

Questions:

- ▶ What happens if the min ratio test fails to give us a value θ by which we can safely increase the entering variable?
- ▶ How do we find the initial basic feasible solution?
- ▶ Is there always a basis B such that

$$(c_N^T - c_B^T A_B^{-1} A_N) \leq 0 ?$$

Then we can terminate because we know that the solution is optimal.

- ▶ If yes how do we make sure that we reach such a basis?

Min Ratio Test

The min ratio test computes a value $\theta \geq 0$ such that after setting the entering variable to θ the leaving variable becomes 0 and all other variables stay non-negative.

For this, one computes b_i/A_{ie} for all constraints i and calculates the minimum positive value.

What does it mean that the ratio b_i/A_{ie} (and hence A_{ie}) is negative for a constraint?

This means that the corresponding basic variable will increase if we increase b . Hence, there is no danger of this basic variable becoming negative

What happens if all b_i/A_{ie} are negative? Then we do not have a leaving variable. **Then the LP is unbounded!**

Termination

The objective function does not decrease during one iteration of the simplex-algorithm.

Does it always increase?

Termination

The objective function may not increase!

Because a variable x_ℓ with $\ell \in B$ is already 0.

The set of inequalities is **degenerate** (also the basis is degenerate).

Definition 28 (Degeneracy)

A BFS x^* is called **degenerate** if the set $J = \{j \mid x_j^* > 0\}$ fulfills $|J| < m$.

It is possible that the algorithm **cycles**, i.e., it cycles through a sequence of different bases without ever terminating. Happens, very rarely in practise.

Non Degenerate Example

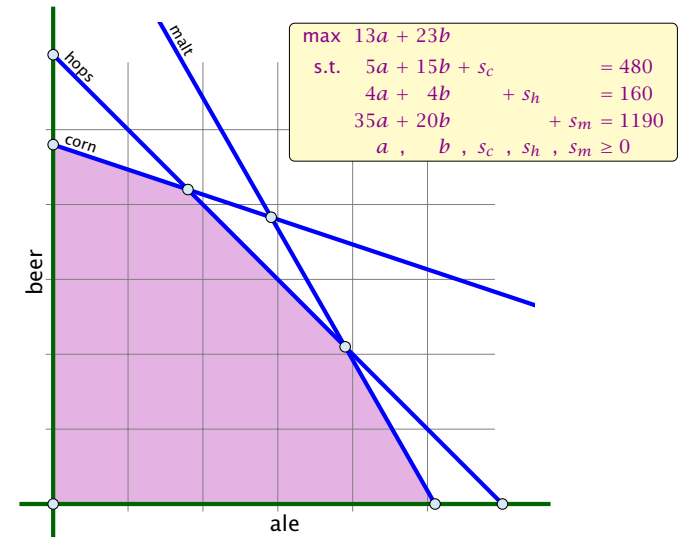

Degenerate Example

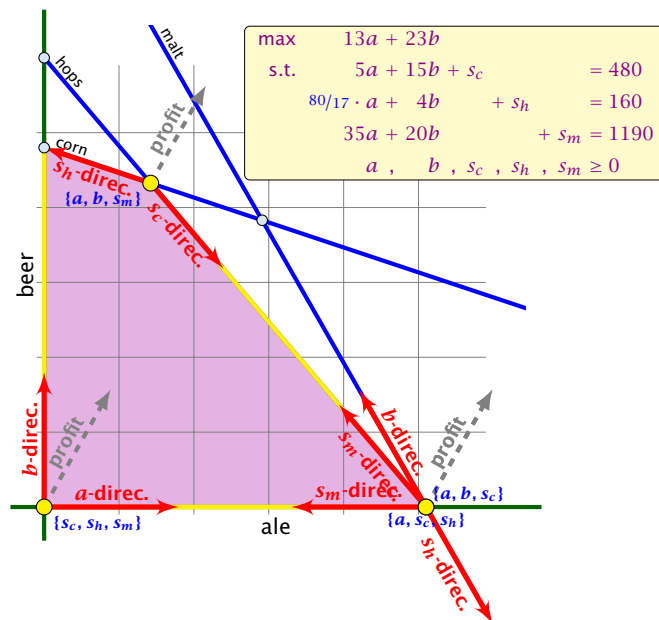

Summary: How to choose pivot-elements

- ▶ We can choose a column e as an entering variable if $\tilde{c}_e > 0$ (\tilde{c}_e is reduced cost for x_e).
- ▶ The standard choice is the column that maximizes \tilde{c}_e .
- ▶ If $A_{ie} \leq 0$ for all $i \in \{1, \dots, m\}$ then the maximum is not bounded.
- ▶ Otw. choose a leaving variable ℓ such that $b_\ell / A_{\ell e}$ is minimal among all variables i with $A_{ie} > 0$.
- ▶ If several variables have minimum $b_\ell / A_{\ell e}$ you reach a **degenerate** basis.
- ▶ Depending on the choice of ℓ it may happen that the algorithm runs into a cycle where it does not escape from a degenerate vertex.

Termination

What do we have so far?

Suppose we are given an initial feasible solution to an LP. If the LP is non-degenerate then Simplex will terminate.

Note that we either terminate because the min-ratio test fails and we can conclude that the LP is **unbounded**, or we terminate because the vector of reduced cost is non-positive. In the latter case we have an **optimum solution**.

How do we come up with an initial solution?

- ▶ $Ax \leq b, x \geq 0$, and $b \geq 0$.
- ▶ The standard slack form for this problem is $Ax + Is = b, x \geq 0, s \geq 0$, where s denotes the vector of slack variables.
- ▶ Then $s = b, x = 0$ is a basic feasible solution (how?).
- ▶ We directly can start the simplex algorithm.

How do we find an initial basic feasible solution for an arbitrary problem?

Two phase algorithm

Suppose we want to maximize $c^T x$ s.t. $Ax = b, x \geq 0$.

1. Multiply all rows with $b_i < 0$ by -1 .
2. maximize $-\sum_i v_i$ s.t. $Ax + Iv = b, x \geq 0, v \geq 0$ using Simplex. $x = 0, v = b$ is initial feasible.
3. If $\sum_i v_i > 0$ then the original problem is **infeasible**.
4. Otw. you have $x \geq 0$ with $Ax = b$.
5. From this you can get basic feasible solution.
6. Now you can start the Simplex for the original problem.

Optimality

Lemma 29

Let B be a basis and x^* a BFS corresponding to basis B . $\tilde{c} \leq 0$ implies that x^* is an optimum solution to the LP.

Duality

How do we get an upper bound to a maximization LP?

$$\begin{aligned} \max \quad & 13a + 23b \\ \text{s.t.} \quad & 5a + 15b \leq 480 \\ & 4a + 4b \leq 160 \\ & 35a + 20b \leq 1190 \\ & a, b \geq 0 \end{aligned}$$

Note that a lower bound is easy to derive. Every choice of $a, b \geq 0$ gives us a lower bound (e.g. $a = 12, b = 28$ gives us a lower bound of 800).

If you take a conic combination of the rows (multiply the i -th row with $y_i \geq 0$) such that $\sum_i y_i a_{ij} \geq c_j$ then $\sum_i y_i b_i$ will be an upper bound.

Duality

Definition 30

Let $z = \max\{c^T x \mid Ax \leq b, x \geq 0\}$ be a linear program P (called the primal linear program).

The linear program D defined by

$$w = \min\{b^T y \mid A^T y \geq c, y \geq 0\}$$

is called the **dual problem**.

Duality

Lemma 31

The dual of the dual problem is the primal problem.

Proof:

- ▶ $w = \min\{b^T y \mid A^T y \geq c, y \geq 0\}$
- ▶ $w = -\max\{-b^T y \mid -A^T y \leq -c, y \geq 0\}$

The dual problem is

- ▶ $z = -\min\{-c^T x \mid -Ax \geq -b, x \geq 0\}$
- ▶ $z = \max\{c^T x \mid Ax \leq b, x \geq 0\}$

Weak Duality

Let $z = \max\{c^T x \mid Ax \leq b, x \geq 0\}$ and $w = \min\{b^T y \mid A^T y \geq c, y \geq 0\}$ be a primal dual pair.

x is primal feasible iff $x \in \{x \mid Ax \leq b, x \geq 0\}$

y is dual feasible, iff $y \in \{y \mid A^T y \geq c, y \geq 0\}$.

Theorem 32 (Weak Duality)

Let \hat{x} be primal feasible and let \hat{y} be dual feasible. Then

$$c^T \hat{x} \leq z \leq w \leq b^T \hat{y} .$$

Weak Duality

$$A^T \hat{y} \geq c \Rightarrow \hat{x}^T A^T \hat{y} \geq \hat{x}^T c \quad (\hat{x} \geq 0)$$

$$A \hat{x} \leq b \Rightarrow y^T A \hat{x} \leq y^T b \quad (y \geq 0)$$

This gives

$$c^T \hat{x} \leq y^T A \hat{x} \leq b^T y .$$

Since, there exists primal feasible \hat{x} with $c^T \hat{x} = z$, and dual feasible \hat{y} with $b^T \hat{y} = w$ we get $z \leq w$.

If P is unbounded then D is infeasible.

5.2 Simplex and Duality

The following linear programs form a primal dual pair:

$$z = \max\{c^T x \mid Ax = b, x \geq 0\}$$

$$w = \min\{b^T y \mid A^T y \geq c\}$$

This means for computing the dual of a standard form LP, we do not have non-negativity constraints for the dual variables.

Proof

Primal:

$$\begin{aligned} & \max\{c^T x \mid Ax = b, x \geq 0\} \\ & = \max\{c^T x \mid Ax \leq b, -Ax \leq -b, x \geq 0\} \\ & = \max\{c^T x \mid \begin{bmatrix} A \\ -A \end{bmatrix} x \leq \begin{bmatrix} b \\ -b \end{bmatrix}, x \geq 0\} \end{aligned}$$

Dual:

$$\begin{aligned} & \min\{[b^T \ -b^T] y \mid [A^T \ -A^T] y \geq c, y \geq 0\} \\ & = \min \left\{ [b^T \ -b^T] \cdot \begin{bmatrix} y^+ \\ y^- \end{bmatrix} \mid [A^T \ -A^T] \cdot \begin{bmatrix} y^+ \\ y^- \end{bmatrix} \geq c, y^- \geq 0, y^+ \geq 0 \right\} \\ & = \min \{ b^T \cdot (y^+ - y^-) \mid A^T \cdot (y^+ - y^-) \geq c, y^- \geq 0, y^+ \geq 0 \} \\ & = \min \{ b^T y' \mid A^T y' \geq c \} \end{aligned}$$

Proof of Optimality Criterion for Simplex

Suppose that we have a basic feasible solution with **reduced cost**

$$\tilde{c} = c^T - c_B^T A_B^{-1} A \leq 0$$

This is equivalent to $A^T (A_B^{-1})^T c_B \geq c$

$y^* = (A_B^{-1})^T c_B$ is solution to the **dual** $\min\{b^T y \mid A^T y \geq c\}$.

$$\begin{aligned} b^T y^* & = (Ax^*)^T y^* = (A_B x_B^*)^T y^* \\ & = (A_B x_B^*)^T (A_B^{-1})^T c_B = (x_B^*)^T A_B^T (A_B^{-1})^T c_B \\ & = c^T x^* \end{aligned}$$

Hence, the solution is optimal.

5.3 Strong Duality

$$P = \max\{c^T x \mid Ax \leq b, x \geq 0\}$$

n_A : number of variables, m_A : number of constraints

We can put the non-negativity constraints into A (which gives us unrestricted variables): $\bar{P} = \max\{c^T x \mid \bar{A}x \leq \bar{b}\}$

$$n_{\bar{A}} = n_A, m_{\bar{A}} = m_A + n_A$$

$$\text{Dual } D = \min\{\bar{b}^T y \mid \bar{A}^T y = c, y \geq 0\}.$$

5.3 Strong Duality

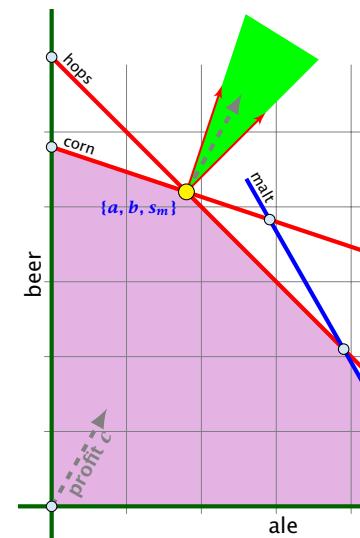

If we have a conic combination y of c then $b^T y$ is an upper bound of the profit we can obtain (**weak duality**):

$$c^T x = (\bar{A}^T y)^T x = y^T \bar{A}x \leq y^T \bar{b}$$

If x and y are optimal then the **duality gap** is 0 (**strong duality**). This means

$$\begin{aligned} 0 &= c^T x - y^T \bar{b} \\ &= (\bar{A}^T y)^T x - y^T \bar{b} \\ &= y^T (\bar{A}x - \bar{b}) \end{aligned}$$

The last term can only be 0 if y_i is 0 whenever the i -th constraint is not tight. This means we have a conic combination of c by normals (columns of \bar{A}^T) of **tight** constraints.

Conversely, if we have x such that the normals of tight constraint (at x) give rise to a conic combination of c , we know that x is optimal.

The profit vector c lies in the cone generated by the normals for the hops and the corn constraint (the tight constraints).

Strong Duality

Theorem 33 (Strong Duality)

Let P and D be a primal dual pair of linear programs, and let z^* and w^* denote the optimal solution to P and D , respectively.

Then

$$z^* = w^*$$

Lemma 34 (Weierstrass)

Let X be a compact set and let $f(x)$ be a continuous function on X . Then $\min\{f(x) : x \in X\}$ exists.

(without proof)

Lemma 35 (Projection Lemma)

Let $X \subseteq \mathbb{R}^m$ be a non-empty convex set, and let $y \notin X$. Then there exist $x^* \in X$ with minimum distance from y . Moreover for all $x \in X$ we have $(y - x^*)^T(x - x^*) \leq 0$.

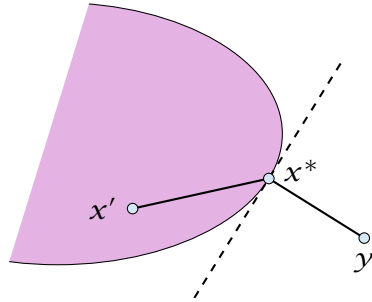

Proof of the Projection Lemma

- ▶ Define $f(x) = \|y - x\|$.
- ▶ We want to apply Weierstrass but X may not be bounded.
- ▶ $X \neq \emptyset$. Hence, there exists $x' \in X$.
- ▶ Define $X' = \{x \in X \mid \|y - x\| \leq \|y - x'\|\}$. This set is closed and bounded.
- ▶ Applying Weierstrass gives the existence.

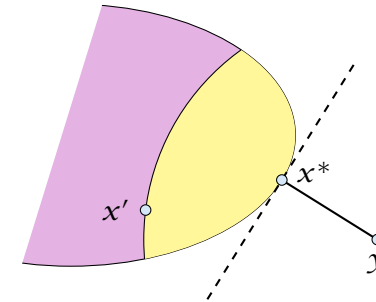

Proof of the Projection Lemma (continued)

x^* is minimum. Hence $\|y - x^*\|^2 \leq \|y - x\|^2$ for all $x \in X$.

By **convexity**: $x \in X$ then $x^* + \epsilon(x - x^*) \in X$ for all $0 \leq \epsilon \leq 1$.

$$\begin{aligned} \|y - x^*\|^2 &\leq \|y - x^* - \epsilon(x - x^*)\|^2 \\ &= \|y - x^*\|^2 + \epsilon^2 \|x - x^*\|^2 - 2\epsilon(y - x^*)^T(x - x^*) \end{aligned}$$

Hence, $(y - x^*)^T(x - x^*) \leq \frac{1}{2}\epsilon \|x - x^*\|^2$.

Letting $\epsilon \rightarrow 0$ gives the result.

Theorem 36 (Separating Hyperplane)

Let $X \subseteq \mathbb{R}^m$ be a non-empty closed convex set, and let $y \notin X$. Then there exists a **separating hyperplane** $\{x \in \mathbb{R}^m : a^T x = \alpha\}$ where $a \in \mathbb{R}^m$, $\alpha \in \mathbb{R}$ that **separates** y from X . ($a^T y < \alpha$; $a^T x \geq \alpha$ for all $x \in X$)

Proof of the Hyperplane Lemma

- ▶ Let $x^* \in X$ be closest point to y in X .
- ▶ By previous lemma $(y - x^*)^T(x - x^*) \leq 0$ for all $x \in X$.
- ▶ Choose $a = (x^* - y)$ and $\alpha = a^T x^*$.
- ▶ For $x \in X$: $a^T(x - x^*) \geq 0$, and, hence, $a^T x \geq \alpha$.
- ▶ Also, $a^T y = a^T(x^* - a) = \alpha - \|a\|^2 < \alpha$

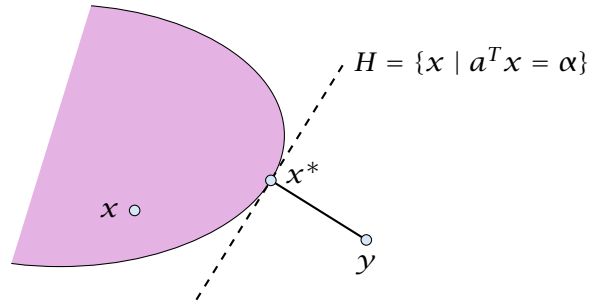

Lemma 37 (Farkas Lemma)

Let A be an $m \times n$ matrix, $b \in \mathbb{R}^m$. Then *exactly one* of the following statements holds.

1. $\exists x \in \mathbb{R}^n$ with $Ax = b, x \geq 0$
2. $\exists y \in \mathbb{R}^m$ with $A^T y \geq 0, b^T y < 0$

Assume \hat{x} satisfies 1. and \hat{y} satisfies 2. Then

$$0 > \hat{y}^T b = \hat{y}^T A \hat{x} \geq 0$$

Hence, at most one of the statements can hold.

Farkas Lemma

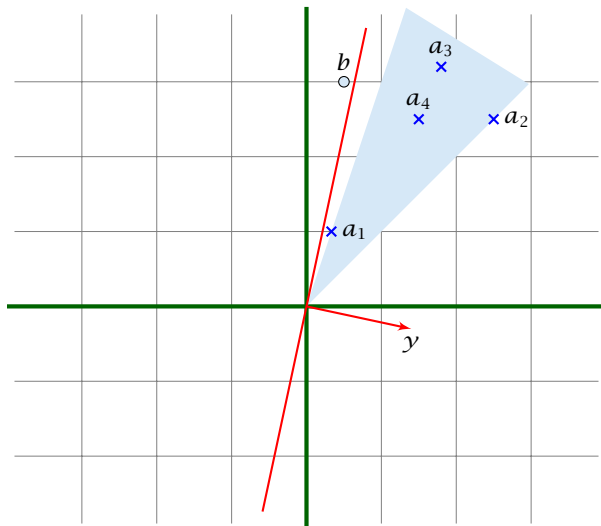

If b is not in the cone generated by the columns of A , there exists a hyperplane y that separates b from the cone.

Proof of Farkas Lemma

Now, assume that 1. does not hold.

Consider $S = \{Ax : x \geq 0\}$ so that S closed, convex, $b \notin S$.

We want to show that there is y with $A^T y \geq 0, b^T y < 0$.

Let y be a hyperplane that separates b from S . Hence, $y^T b < \alpha$ and $y^T s \geq \alpha$ for all $s \in S$.

$$0 \in S \Rightarrow \alpha \leq 0 \Rightarrow y^T b < 0$$

$y^T Ax \geq \alpha$ for all $x \geq 0$. Hence, $y^T A \geq 0$ as we can choose x arbitrarily large.

Lemma 38 (Farkas Lemma; different version)

Let A be an $m \times n$ matrix, $b \in \mathbb{R}^m$. Then exactly one of the following statements holds.

1. $\exists x \in \mathbb{R}^n$ with $Ax \leq b, x \geq 0$
2. $\exists y \in \mathbb{R}^m$ with $A^T y \geq 0, b^T y < 0, y \geq 0$

Rewrite the conditions:

1. $\exists x \in \mathbb{R}^n$ with $\begin{bmatrix} A & I \end{bmatrix} \cdot \begin{bmatrix} x \\ s \end{bmatrix} = b, x \geq 0, s \geq 0$
2. $\exists y \in \mathbb{R}^m$ with $\begin{bmatrix} A^T \\ I \end{bmatrix} y \geq 0, b^T y < 0$

Proof of Strong Duality

$$P: z = \max\{c^T x \mid Ax \leq b, x \geq 0\}$$

$$D: w = \min\{b^T y \mid A^T y \geq c, y \geq 0\}$$

Theorem 39 (Strong Duality)

Let P and D be a primal dual pair of linear programs, and let z and w denote the optimal solution to P and D , respectively (i.e., P and D are non-empty). Then

$$z = w .$$

Proof of Strong Duality

$z \leq w$: follows from weak duality

$z \geq w$:

We show $z < \alpha$ implies $w < \alpha$.

$$\begin{array}{l} \exists x \in \mathbb{R}^n \\ \text{s.t. } Ax \leq b \\ \quad -c^T x \leq -\alpha \\ \quad x \geq 0 \end{array}$$

$$\begin{array}{l} \exists y \in \mathbb{R}^m; v \in \mathbb{R} \\ \text{s.t. } A^T y - cv \geq 0 \\ \quad b^T y - \alpha v < 0 \\ \quad y, v \geq 0 \end{array}$$

From the definition of α we know that the first system is infeasible; hence the second must be feasible.

Proof of Strong Duality

$$\begin{array}{l} \exists y \in \mathbb{R}^m; v \in \mathbb{R} \\ \text{s.t. } A^T y - cv \geq 0 \\ \quad b^T y - \alpha v < 0 \\ \quad y, v \geq 0 \end{array}$$

If the solution y, v has $v = 0$ we have that

$$\begin{array}{l} \exists y \in \mathbb{R}^m \\ \text{s.t. } A^T y \geq 0 \\ \quad b^T y < 0 \\ \quad y \geq 0 \end{array}$$

is feasible. By Farkas lemma this gives that LP P is infeasible. Contradiction to the assumption of the lemma.

Proof of Strong Duality

Hence, there exists a solution y, v with $v > 0$.

We can rescale this solution (scaling both y and v) s.t. $v = 1$.

Then y is feasible for the dual but $b^T y < \alpha$. This means that $w < \alpha$.

Fundamental Questions

Definition 40 (Linear Programming Problem (LP))

Let $A \in \mathbb{Q}^{m \times n}$, $b \in \mathbb{Q}^m$, $c \in \mathbb{Q}^n$, $\alpha \in \mathbb{Q}$. Does there exist $x \in \mathbb{Q}^n$ s.t. $Ax = b$, $x \geq 0$, $c^T x \geq \alpha$?

Questions:

- ▶ Is LP in NP?
- ▶ Is LP in co-NP? yes!
- ▶ Is LP in P?

Proof:

- ▶ Given a primal maximization problem P and a parameter α . Suppose that $\alpha > \text{opt}(P)$.
- ▶ We can prove this by providing an optimal basis for the dual.
- ▶ A verifier can check that the associated dual solution fulfills all dual constraints and that it has dual cost $< \alpha$.

Complementary Slackness

Lemma 41

Assume a linear program $P = \max\{c^T x \mid Ax \leq b; x \geq 0\}$ has solution x^* and its dual $D = \min\{b^T y \mid A^T y \geq c; y \geq 0\}$ has solution y^* .

1. If $x_j^* > 0$ then the j -th constraint in D is tight.
2. If the j -th constraint in D is not tight than $x_j^* = 0$.
3. If $y_i^* > 0$ then the i -th constraint in P is tight.
4. If the i -th constraint in P is not tight than $y_i^* = 0$.

If we say that a variable x_j^* (y_i^*) has slack if $x_j^* > 0$ ($y_i^* > 0$), (i.e., the corresponding variable restriction is not tight) and a constraint has slack if it is not tight, then the above says that for a primal-dual solution pair it is not possible that a constraint **and** its corresponding (dual) variable has slack.

Proof: Complementary Slackness

Analogous to the proof of weak duality we obtain

$$c^T x^* \leq y^{*T} A x^* \leq b^T y^*$$

Because of strong duality we then get

$$c^T x^* = y^{*T} A x^* = b^T y^*$$

This gives e.g.

$$\sum_j (y^T A - c^T)_j x_j^* = 0$$

From the constraint of the dual it follows that $y^T A \geq c^T$. Hence the left hand side is a sum over the product of non-negative numbers. Hence, if e.g. $(y^T A - c^T)_j > 0$ (the j -th constraint in the dual is not tight) then $x_j = 0$ (2.). The result for (1./3./4.) follows similarly.

Interpretation of Dual Variables

- ▶ Brewer: find mix of ale and beer that maximizes profits

$$\begin{aligned} \max \quad & 13a + 23b \\ \text{s.t.} \quad & 5a + 15b \leq 480 \\ & 4a + 4b \leq 160 \\ & 35a + 20b \leq 1190 \\ & a, b \geq 0 \end{aligned}$$

- ▶ Entrepreneur: buy resources from brewer at minimum cost
 C, H, M : unit price for corn, hops and malt.

$$\begin{aligned} \min \quad & 480C + 160H + 1190M \\ \text{s.t.} \quad & 5C + 4H + 35M \geq 13 \\ & 15C + 4H + 20M \geq 23 \\ & C, H, M \geq 0 \end{aligned}$$

Note that brewer won't sell (at least not all) if e.g.
 $5C + 4H + 35M < 13$ as then brewing ale would be advantageous.

Interpretation of Dual Variables

Marginal Price:

- ▶ How much money is the brewer willing to pay for additional amount of Corn, Hops, or Malt?
- ▶ We are interested in the marginal price, i.e., what happens if we increase the amount of Corn, Hops, and Malt by ϵ_C, ϵ_H , and ϵ_M , respectively.

The profit increases to $\max\{c^T x \mid Ax \leq b + \epsilon; x \geq 0\}$. Because of strong duality this is equal to

$$\begin{aligned} \min \quad & (b^T + \epsilon^T)y \\ \text{s.t.} \quad & A^T y \geq c \\ & y \geq 0 \end{aligned}$$

Interpretation of Dual Variables

If ϵ is "small" enough then the optimum dual solution y^* might not change. Therefore the profit increases by $\sum_i \epsilon_i y_i^*$.

Therefore we can interpret the dual variables as **marginal prices**.

Note that with this interpretation, complementary slackness becomes obvious.

- ▶ If the brewer has slack of some resource (e.g. corn) then he is not willing to pay anything for it (corresponding dual variable is zero).
- ▶ If the dual variable for some resource is non-zero, then an increase of this resource increases the profit of the brewer. Hence, it makes no sense to have left-overs of this resource. Therefore its slack must be zero.

Example

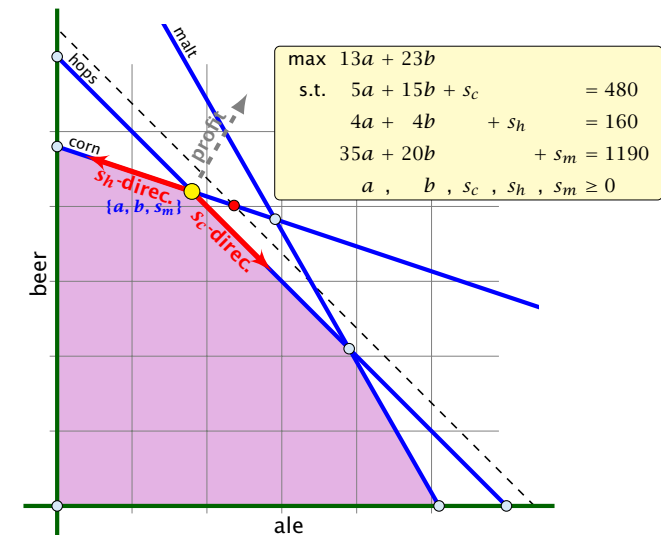

The change in profit when increasing hops by one unit is

$$= \underbrace{c_B^T A_B^{-1}}_{y^*} e_h.$$

Of course, the previous argument about the increase in the primal objective only holds for the non-degenerate case.

If the optimum basis is degenerate then increasing the supply of one resource may not allow the objective value to increase.

Flows

Definition 42

An (s, t) -flow in a (complete) directed graph $G = (V, V \times V, c)$ is a function $f : V \times V \rightarrow \mathbb{R}_0^+$ that satisfies

1. For each edge (x, y)

$$0 \leq f_{xy} \leq c_{xy} .$$

(capacity constraints)

2. For each $v \in V \setminus \{s, t\}$

$$\sum_x f_{vx} = \sum_x f_{xv} .$$

(flow conservation constraints)

Flows

Definition 43

The value of an (s, t) -flow f is defined as

$$\text{val}(f) = \sum_x f_{sx} - \sum_x f_{xs} .$$

Maximum Flow Problem:

Find an (s, t) -flow with maximum value.

LP-Formulation of Maxflow

$$\begin{array}{ll} \max & \sum_z f_{sz} - \sum_z f_{zs} \\ \text{s.t.} & \forall (z, w) \in V \times V \quad f_{zw} \leq c_{zw} \quad l_{zw} \\ & \forall w \neq s, t \quad \sum_z f_{zw} - \sum_z f_{wz} = 0 \quad p_w \\ & f_{zw} \geq 0 \end{array}$$

$$\begin{array}{ll} \min & \sum_{(xy)} c_{xy} l_{xy} \\ \text{s.t.} & f_{xy} (x, y \neq s, t) : 1l_{xy} - 1p_x + 1p_y \geq 0 \\ & f_{sy} (y \neq s, t) : 1l_{sy} \quad + 1p_y \geq 1 \\ & f_{xs} (x \neq s, t) : 1l_{xs} - 1p_x \geq -1 \\ & f_{ty} (y \neq s, t) : 1l_{ty} \quad + 1p_y \geq 0 \\ & f_{xt} (x \neq s, t) : 1l_{xt} - 1p_x \geq 0 \\ & f_{st} : 1l_{st} \geq 1 \\ & f_{ts} : 1l_{ts} \geq -1 \\ & l_{xy} \geq 0 \end{array}$$

LP-Formulation of Maxflow

$$\begin{array}{ll}
 \min & \sum_{(x,y)} c_{xy} l_{xy} \\
 \text{s.t.} & f_{xy} (x, y \neq s, t) : 1l_{xy} - 1p_x + 1p_y \geq 0 \\
 & f_{sy} (y \neq s, t) : 1l_{sy} - 1 + 1p_y \geq 0 \\
 & f_{xs} (x \neq s, t) : 1l_{xs} - 1p_x + 1 \geq 0 \\
 & f_{ty} (y \neq s, t) : 1l_{ty} - 0 + 1p_y \geq 0 \\
 & f_{xt} (x \neq s, t) : 1l_{xt} - 1p_x + 0 \geq 0 \\
 & f_{st} : 1l_{st} - 1 + 0 \geq 0 \\
 & f_{ts} : 1l_{ts} - 0 + 1 \geq 0 \\
 & l_{xy} \geq 0
 \end{array}$$

LP-Formulation of Maxflow

$$\begin{array}{ll}
 \min & \sum_{(x,y)} c_{xy} l_{xy} \\
 \text{s.t.} & f_{xy} (x, y \neq s, t) : 1l_{xy} - 1p_x + 1p_y \geq 0 \\
 & f_{sy} (y \neq s, t) : 1l_{sy} - p_s + 1p_y \geq 0 \\
 & f_{xs} (x \neq s, t) : 1l_{xs} - 1p_x + p_s \geq 0 \\
 & f_{ty} (y \neq s, t) : 1l_{ty} - p_t + 1p_y \geq 0 \\
 & f_{xt} (x \neq s, t) : 1l_{xt} - 1p_x + p_t \geq 0 \\
 & f_{st} : 1l_{st} - p_s + p_t \geq 0 \\
 & f_{ts} : 1l_{ts} - p_t + p_s \geq 0 \\
 & l_{xy} \geq 0
 \end{array}$$

with $p_t = 0$ and $p_s = 1$.

LP-Formulation of Maxflow

$$\begin{array}{ll}
 \min & \sum_{(x,y)} c_{xy} l_{xy} \\
 \text{s.t.} & f_{xy} : 1l_{xy} - 1p_x + 1p_y \geq 0 \\
 & l_{xy} \geq 0 \\
 & p_s = 1 \\
 & p_t = 0
 \end{array}$$

We can interpret the l_{xy} value as assigning a length to every edge.

The value p_x for a variable, then can be seen as the distance of x to t (where the distance from s to t is required to be 1 since $p_s = 1$).

The constraint $p_x \leq l_{xy} + p_y$ then simply follows from triangle inequality ($d(x, t) \leq d(x, y) + d(y, t) \Rightarrow d(x, t) \leq l_{xy} + d(y, t)$).

One can show that there is an optimum LP-solution for the dual problem that gives an integral assignment of variables.

This means $p_x = 1$ or $p_x = 0$ for our case. This gives rise to a cut in the graph with vertices having value 1 on one side and the other vertices on the other side. The objective function then evaluates the capacity of this cut.

This shows that the Maxflow/Mincut theorem follows from linear programming duality.

Degeneracy Revisited

If a basis variable is 0 in the basic feasible solution then we may not make progress during an iteration of simplex.

Idea:

Change $LP := \max\{c^T x, Ax = b; x \geq 0\}$ into

$LP' := \max\{c^T x, Ax = b', x \geq 0\}$ such that

- I. LP is feasible
- II. If a set B of basis variables corresponds to an **infeasible** basis (i.e. $A_B^{-1}b \not\geq 0$) then B corresponds to an infeasible basis in LP' (note that columns in A_B are linearly independent).
- III. LP has no degenerate basic solutions

Degenerate Example

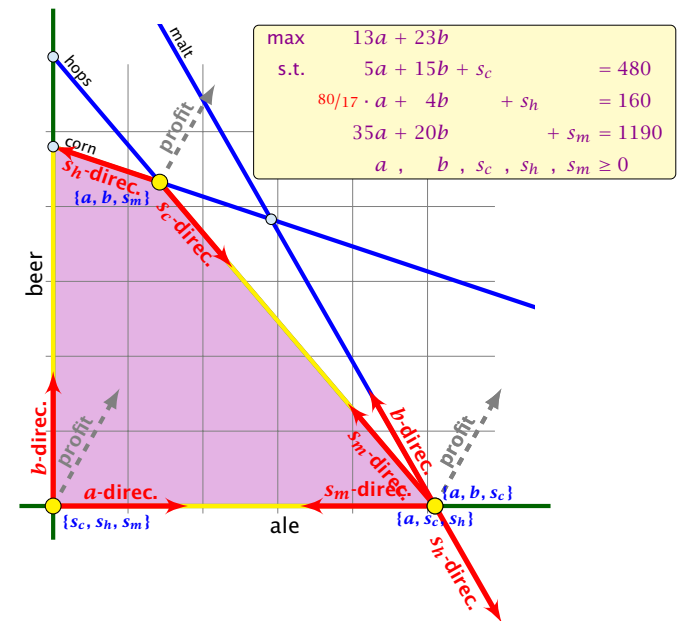

Degeneracy Revisited

If a basis variable is 0 in the basic feasible solution then we may not make progress during an iteration of simplex.

Idea:

Given feasible $LP := \max\{c^T x, Ax = b; x \geq 0\}$. Change it into

$LP' := \max\{c^T x, Ax = b', x \geq 0\}$ such that

- I. LP' is feasible
- II. If a set B of basis variables corresponds to an **infeasible** basis (i.e. $A_B^{-1}b \not\geq 0$) then B corresponds to an infeasible basis in LP' (note that columns in A_B are linearly independent).
- III. LP' has no degenerate basic solutions

Perturbation

Let B be index set of **some** basis with basic solution

$$x_B^* = A_B^{-1}b \geq 0, x_N^* = 0 \quad (\text{i.e. } B \text{ is feasible})$$

Fix

$$b' := b + A_B \begin{pmatrix} \varepsilon \\ \vdots \\ \varepsilon^m \end{pmatrix} \text{ for } \varepsilon > 0.$$

This is the perturbation that we are using.

Property I

The new LP is feasible because the set B of basis variables provides a feasible basis:

$$A_B^{-1} \left(b + A_B \begin{pmatrix} \epsilon \\ \vdots \\ \epsilon^m \end{pmatrix} \right) = x_B^* + \begin{pmatrix} \epsilon \\ \vdots \\ \epsilon^m \end{pmatrix} \geq 0 .$$

Property II

Let \tilde{B} be a non-feasible basis. This means $(A_{\tilde{B}}^{-1}b)_i < 0$ for some row i .

Then for small enough $\epsilon > 0$

$$\left(A_{\tilde{B}}^{-1} \left(b + A_B \begin{pmatrix} \epsilon \\ \vdots \\ \epsilon^m \end{pmatrix} \right) \right)_i = (A_{\tilde{B}}^{-1}b)_i + \left(A_{\tilde{B}}^{-1}A_B \begin{pmatrix} \epsilon \\ \vdots \\ \epsilon^m \end{pmatrix} \right)_i < 0$$

Hence, \tilde{B} is not feasible.

Property III

Let \tilde{B} be a basis. It has an associated solution

$$x_{\tilde{B}}^* = A_{\tilde{B}}^{-1}b + A_{\tilde{B}}^{-1}A_B \begin{pmatrix} \epsilon \\ \vdots \\ \epsilon^m \end{pmatrix}$$

in the perturbed instance.

We can view each component of the vector as a polynomial with variable ϵ of degree at most m .

$A_{\tilde{B}}^{-1}A_B$ has rank m . Therefore no polynomial is 0.

A polynomial of degree at most m has at most m roots (Nullstellen).

Hence, $\epsilon > 0$ small enough gives that no component of the above vector is 0. Hence, no degeneracies.

Since, there are no degeneracies Simplex will terminate when run on LP'.

- ▶ If it terminates because the reduced cost vector fulfills

$$\tilde{c} = (c^T - c_B^T A_B^{-1}A) \leq 0$$

then we have found an optimal basis. Note that this basis is also optimal for LP, as the above constraint does not depend on b .

- ▶ If it terminates because it finds a variable x_j with $\tilde{c}_j > 0$ for which the j -th basis direction d , fulfills $d \geq 0$ we know that LP' is unbounded. The basis direction does not depend on b . Hence, we also know that LP is unbounded.

Lexicographic Pivoting

Doing calculations with perturbed instances may be costly. Also the right choice of ε is difficult.

Idea:

Simulate behaviour of LP' without explicitly doing a perturbation.

Lexicographic Pivoting

We choose the entering variable arbitrarily as before ($\tilde{c}_e > 0$, of course).

If we do not have a choice for the leaving variable then LP' and LP do the same (i.e., choose the same variable).

Otherwise we have to be careful.

Lexicographic Pivoting

In the following we assume that $b \geq 0$. This can be obtained by replacing the initial system $(A \mid b)$ by $(A_B^{-1}A \mid A_B^{-1}b)$ where B is the index set of a feasible basis (found e.g. by the first phase of the Two-phase algorithm).

Then the perturbed instance is

$$b' = b + \begin{pmatrix} \varepsilon \\ \vdots \\ \varepsilon^m \end{pmatrix}$$

Matrix View

Let our linear program be

$$\begin{aligned} c_B^T x_B + c_N^T x_N &= Z \\ A_B x_B + A_N x_N &= b \\ x_B, x_N &\geq 0 \end{aligned}$$

The simplex tableaux for basis B is

$$\begin{aligned} (c_N^T - c_B^T A_B^{-1} A_N) x_N &= Z - c_B^T A_B^{-1} b \\ I x_B + A_B^{-1} A_N x_N &= A_B^{-1} b \\ x_B, x_N &\geq 0 \end{aligned}$$

The BFS is given by $x_N = 0, x_B = A_B^{-1}b$.

If $(c_N^T - c_B^T A_B^{-1} A_N) \leq 0$ we know that we have an optimum solution.

Lexicographic Pivoting

LP chooses an arbitrary leaving variable that has $\hat{A}_{\ell e} > 0$ and minimizes

$$\theta_\ell = \frac{\hat{b}_\ell}{\hat{A}_{\ell e}} = \frac{(A_B^{-1}b)_\ell}{(A_B^{-1}A_{*e})_\ell}.$$

ℓ is the index of a leaving variable within B . This means if e.g. $B = \{1, 3, 7, 14\}$ and leaving variable is 3 then $\ell = 2$.

Lexicographic Pivoting

Definition 44

$u \leq_{\text{lex}} v$ if and only if the first component in which u and v differ fulfills $u_i \leq v_i$.

Lexicographic Pivoting

LP' chooses an index that minimizes

$$\begin{aligned} \theta_\ell &= \frac{\left(A_B^{-1} \left(b + \begin{pmatrix} \varepsilon \\ \vdots \\ \varepsilon^m \end{pmatrix} \right) \right)_\ell}{(A_B^{-1}A_{*e})_\ell} = \frac{\left(A_B^{-1}(b | I) \begin{pmatrix} 1 \\ \varepsilon \\ \vdots \\ \varepsilon^m \end{pmatrix} \right)_\ell}{(A_B^{-1}A_{*e})_\ell} \\ &= \frac{\ell\text{-th row of } A_B^{-1}(b | I)}{(A_B^{-1}A_{*e})_\ell} \begin{pmatrix} 1 \\ \varepsilon \\ \vdots \\ \varepsilon^m \end{pmatrix} \end{aligned}$$

Lexicographic Pivoting

This means you can choose the variable/row ℓ for which the vector

$$\frac{\ell\text{-th row of } A_B^{-1}(b | I)}{(A_B^{-1}A_{*e})_\ell}$$

is lexicographically minimal.

Of course only including rows with $(A_B^{-1}A_{*e})_\ell > 0$.

This technique guarantees that your pivoting is the same as in the perturbed case. This guarantees that cycling does not occur.

Number of Simplex Iterations

Each iteration of Simplex can be implemented in polynomial time.

If we use lexicographic pivoting we know that Simplex requires at most $\binom{n}{m}$ iterations, because it will not visit a basis twice.

The input size is $L \cdot n \cdot m$, where n is the number of variables, m is the number of constraints, and L is the length of the binary representation of the largest coefficient in the matrix A .

If we really require $\binom{n}{m}$ iterations then Simplex is not a polynomial time algorithm.

Can we obtain a better analysis?

Number of Simplex Iterations

Observation

Simplex visits every **feasible** basis at most once.

However, also the number of feasible bases can be very large.

Example

$$\begin{aligned} \max \quad & c^T x \\ \text{s.t.} \quad & 0 \leq x_1 \leq 1 \\ & 0 \leq x_2 \leq 1 \\ & \vdots \\ & 0 \leq x_n \leq 1 \end{aligned}$$

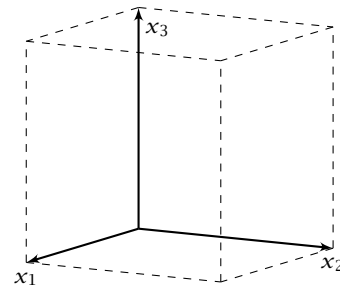

$2n$ constraint on n variables define an n -dimensional hypercube as feasible region.

The feasible region has 2^n vertices.

Example

$$\begin{aligned} \max \quad & c^T x \\ \text{s.t.} \quad & 0 \leq x_1 \leq 1 \\ & 0 \leq x_2 \leq 1 \\ & \vdots \\ & 0 \leq x_n \leq 1 \end{aligned}$$

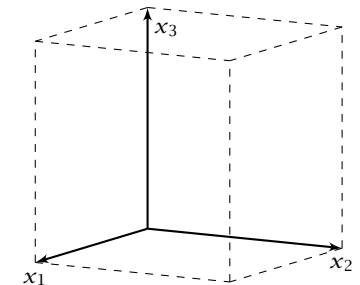

However, Simplex may still run quickly as it usually does not visit all feasible bases.

In the following we give an example of a feasible region for which there is a bad **Pivoting Rule**.

Pivoting Rule

A Pivoting Rule defines how to choose the entering and leaving variable for an iteration of Simplex.

In the non-degenerate case after choosing the entering variable the leaving variable is unique.

Klee Minty Cube

$$\begin{array}{ll} \max & x_n \\ \text{s.t.} & 0 \leq x_1 \leq 1 \\ & \epsilon x_1 \leq x_2 \leq 1 - \epsilon x_1 \\ & \epsilon x_2 \leq x_3 \leq 1 - \epsilon x_2 \\ & \vdots \\ & \epsilon x_{n-1} \leq x_n \leq 1 - \epsilon x_{n-1} \\ & x_i \geq 0 \end{array}$$

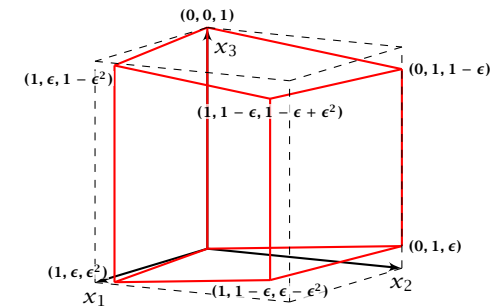

Observations

- ▶ We have $2n$ constraints, and $3n$ variables (after adding slack variables to every constraint).
- ▶ Every basis is defined by $2n$ variables, and n non-basic variables.
- ▶ There exist degenerate vertices.
- ▶ The degeneracies come from the non-negativity constraints, which are superfluous.
- ▶ In the following all variables x_i stay in the basis at all times.
- ▶ Then, we can uniquely specify a basis by choosing for each variable whether it should be equal to its lower bound, or equal to its upper bound (the slack variable corresponding to the non-tight constraint is part of the basis).
- ▶ We can also simply identify each basis/vertex with the corresponding hypercube vertex obtained by letting $\epsilon \rightarrow 0$.

Analysis

- ▶ In the following we specify a sequence of bases (identified by the corresponding hypercube node) along which the objective function strictly increases.
- ▶ The basis $(0, \dots, 0, 1)$ is the unique optimal basis.
- ▶ Our sequence S_n starts at $(0, \dots, 0)$ ends with $(0, \dots, 0, 1)$ and visits every node of the hypercube.
- ▶ An unfortunate Pivoting Rule may choose this sequence, and, hence, require an exponential number of iterations.

Klee Minty Cube

$$\begin{array}{ll} \max & x_n \\ \text{s.t.} & 0 \leq x_1 \leq 1 \\ & \epsilon x_1 \leq x_2 \leq 1 - \epsilon x_1 \\ & \epsilon x_2 \leq x_3 \leq 1 - \epsilon x_2 \end{array}$$

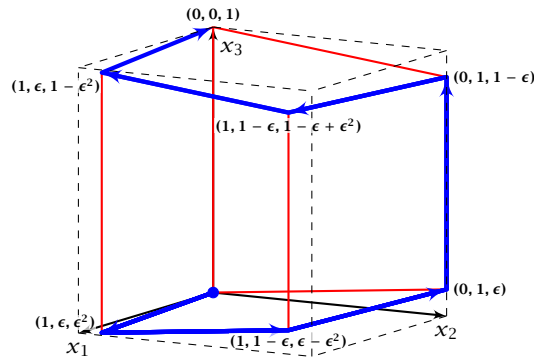

Analysis

The sequence S_n that visits every node of the hypercube is defined recursively

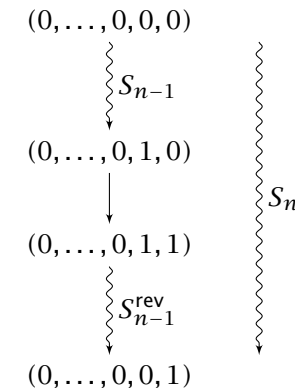

The non-recursive case is $S_1 = 0 \rightarrow 1$

Analysis

Lemma 45

The objective value x_n is increasing along path S_n .

Proof by induction:

$n = 1$: obvious, since $S_1 = 0 \rightarrow 1$, and $1 > 0$.

$n - 1 \rightarrow n$

- ▶ For the first part the value of $x_n = \epsilon x_{n-1}$.
- ▶ By induction hypothesis x_{n-1} is increasing along S_{n-1} , hence, also x_n .
- ▶ Going from $(0, \dots, 0, 1, 0)$ to $(0, \dots, 0, 1, 1)$ increases x_n for small enough ϵ .
- ▶ For the remaining path S_{n-1}^{rev} we have $x_n = 1 - \epsilon x_{n-1}$.
- ▶ By induction hypothesis x_{n-1} is increasing along S_{n-1} , hence $-\epsilon x_{n-1}$ is increasing along S_{n-1}^{rev} .

Remarks about Simplex

Observation

The simplex algorithm takes at most $\binom{n}{m}$ iterations. Each iteration can be implemented in time $\mathcal{O}(mn)$.

In practise it usually takes a linear number of iterations.

Remarks about Simplex

Theorem

For almost all known **deterministic** pivoting rules (rules for choosing entering and leaving variables) there exist lower bounds that require the algorithm to have exponential running time ($\Omega(2^{\Omega(n)})$) (e.g. Klee Minty 1972).

Remarks about Simplex

Theorem

For some standard **randomized** pivoting rules there exist subexponential lower bounds ($\Omega(2^{\Omega(n^\alpha)})$ for $\alpha > 0$) (Friedmann, Hansen, Zwick 2011).

Remarks about Simplex

Conjecture (Hirsch 1957)

The edge-vertex graph of an m -facet polytope in d -dimensional Euclidean space has diameter no more than $m - d$.

The conjecture has been proven wrong in 2010.

But the question whether the diameter is perhaps of the form $\mathcal{O}(\text{poly}(m, d))$ is open.

8 Seidels LP-algorithm

- ▶ Suppose we want to solve $\min\{c^T x \mid Ax \geq b; x \geq 0\}$, where $x \in \mathbb{R}^d$ and we have m constraints.
- ▶ In the worst-case Simplex runs in time roughly $\mathcal{O}(m(m+d)\binom{m+d}{m}) \approx (m+d)^m$. (slightly better bounds on the running time exist, but will not be discussed here).
- ▶ If d is much smaller than m one can do a lot better.
- ▶ In the following we develop an algorithm with running time $\mathcal{O}(d! \cdot m)$, i.e., **linear in m** .

8 Seidels LP-algorithm

Setting:

- ▶ We assume an LP of the form

$$\begin{array}{ll} \min & c^T x \\ \text{s.t.} & Ax \geq b \\ & x \geq 0 \end{array}$$

- ▶ We assume that the LP is **bounded**.

Ensuring Conditions

Given a **standard minimization LP**

$$\begin{array}{ll} \min & c^T x \\ \text{s.t.} & Ax \geq b \\ & x \geq 0 \end{array}$$

how can we obtain an LP of the required form?

- ▶ **Compute a lower bound on $c^T x$ for any basic feasible solution.**

Computing a Lower Bound

Let s denote the smallest common multiple of all denominators of entries in A, b .

Multiply entries in A, b by s to obtain integral entries. **This does not change the feasible region.**

Add slack variables to A ; denote the resulting matrix with \bar{A} .

If B is an optimal basis then x_B with $\bar{A}_B x_B = \bar{b}$, gives an optimal assignment to the basis variables (non-basic variables are 0).

Theorem 46 (Cramers Rule)

Let M be a matrix with $\det(M) \neq 0$. Then the solution to the system $Mx = b$ is given by

$$x_i = \frac{\det(M_j)}{\det(M)},$$

where M_i is the matrix obtained from M by replacing the i -th column by the vector b .

Proof:

- Define

$$X_i = \begin{pmatrix} | & & | & & | \\ e_1 & \cdots & e_{i-1} & x & e_{i+1} & \cdots & e_n \\ | & & | & & | \end{pmatrix}$$

Note that expanding along the i -th column gives that $\det(X_i) = x_i$.

- Further, we have

$$MX_i = \begin{pmatrix} | & & | & & | \\ Me_1 & \cdots & Me_{i-1} & Mx & Me_{i+1} & \cdots & Me_n \\ | & & | & & | \end{pmatrix} = M_i$$

- Hence,

$$x_i = \det(X_i) = \frac{\det(M_i)}{\det(M)}$$

Bounding the Determinant

Let Z be the maximum absolute entry occurring in \bar{A} , \bar{b} or c . Let C denote the matrix obtained from \bar{A}_B by replacing the j -th column with vector \bar{b} (for some j).

Observe that

$$\begin{aligned} |\det(C)| &= \left| \sum_{\pi \in S_m} \text{sgn}(\pi) \prod_{1 \leq i \leq m} C_{i\pi(i)} \right| \\ &\leq \sum_{\pi \in S_m} \prod_{1 \leq i \leq m} |C_{i\pi(i)}| \\ &\leq m! \cdot Z^m \end{aligned}$$

Here $\text{sgn}(\pi)$ denotes the **sign** of the permutation, which is 1 if the permutation can be generated by an even number of transpositions (exchanging two elements), and -1 if the number of transpositions is odd. The first identity is known as Leibniz formula.

Bounding the Determinant

Alternatively, Hadamards inequality gives

$$\begin{aligned} |\det(C)| &\leq \prod_{i=1}^m \|C_{*i}\| \leq \prod_{i=1}^m (\sqrt{m}Z) \\ &\leq m^{m/2} Z^m \end{aligned}$$

Hadamards Inequality

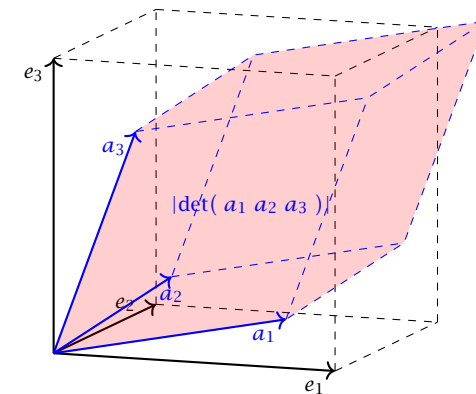

Hadamards inequality says that the volume of the red parallelepiped (**Spat**) is smaller than the volume in the black cube (if $\|e_1\| = \|a_1\|$, $\|e_2\| = \|a_2\|$, $\|e_3\| = \|a_3\|$).

Ensuring Conditions

Given a **standard minimization LP**

$$\begin{array}{ll} \min & c^T x \\ \text{s.t.} & Ax \geq b \\ & x \geq 0 \end{array}$$

how can we obtain an LP of the required form?

- ▶ **Compute a lower bound on $c^T x$ for any basic feasible solution.** Add the constraint $c^T x \geq -dZ(m! \cdot Z^m) - 1$. **Note that this constraint is superfluous unless the LP is unbounded.**

Ensuring Conditions

Compute an optimum basis for the new LP.

- ▶ If the cost is $c^T x = -(dZ)(m! \cdot Z^m) - 1$ we know that the original LP is unbounded.
- ▶ Otw. we have an optimum basis.

In the following we use \mathcal{H} to denote the set of all constraints apart from the constraint $c^T x \geq -dZ(m! \cdot Z^m) - 1$.

We give a routine $\text{SeidelLP}(\mathcal{H}, d)$ that is given a set \mathcal{H} of **explicit, non-degenerate** constraints over d variables, and minimizes $c^T x$ over all feasible points.

In addition it obeys the implicit constraint $c^T x \geq -dZ(m! \cdot Z^m) - 1$.

Algorithm 1 SeidelLP(\mathcal{H}, d)

- 1: **if** $d = 1$ **then** solve 1-dimensional problem and return;
- 2: **if** $\mathcal{H} = \emptyset$ **then** return x on implicit constraint hyperplane
- 3: choose **random** constraint $h \in \mathcal{H}$
- 4: $\hat{\mathcal{H}} \leftarrow \mathcal{H} \setminus \{h\}$
- 5: $\hat{x}^* \leftarrow \text{SeidelLP}(\hat{\mathcal{H}}, d)$
- 6: **if** $\hat{x}^* = \text{infeasible}$ **then return infeasible**
- 7: **if** \hat{x}^* fulfills h **then return** \hat{x}^*
- 8: // **optimal solution fulfills h with equality, i.e., $a_h^T x = b_h$**
- 9: solve $a_h^T x = b_h$ for some variable x_ℓ ;
- 10: eliminate x_ℓ in constraints from $\hat{\mathcal{H}}$ and in implicit constr.;
- 11: $\hat{x}^* \leftarrow \text{SeidelLP}(\hat{\mathcal{H}}, d - 1)$
- 12: **if** $\hat{x}^* = \text{infeasible}$ **then**
- 13: **return infeasible**
- 14: **else**
- 15: add the value of x_ℓ to \hat{x}^* and return the solution

8 Seidels LP-algorithm

Note that for the case $d = 1$, the asymptotic bound $\mathcal{O}(\max\{m, 1\})$ is valid also for the case $m = 0$.

- ▶ If $d = 1$ we can solve the 1-dimensional problem in time $\mathcal{O}(\max\{m, 1\})$.
- ▶ If $d > 1$ and $m = 0$ we take time $\mathcal{O}(d)$ to return d -dimensional vector x .
- ▶ The first recursive call takes time $T(m - 1, d)$ for the call plus $\mathcal{O}(d)$ for checking whether the solution fulfills h .
- ▶ If we are unlucky and \hat{x}^* does not fulfill h we need time $\mathcal{O}(d(m + 1)) = \mathcal{O}(dm)$ to eliminate x_ℓ . Then we make a recursive call that takes time $T(m - 1, d - 1)$.
- ▶ The probability of being unlucky is at most d/m as there are at most d constraints whose removal will decrease the objective function

8 Seidels LP-algorithm

This gives the recurrence

$$T(m, d) = \begin{cases} \mathcal{O}(\max\{1, m\}) & \text{if } d = 1 \\ \mathcal{O}(d) & \text{if } d > 1 \text{ and } m = 0 \\ \mathcal{O}(d) + T(m - 1, d) + \\ \frac{d}{m}(\mathcal{O}(dm) + T(m - 1, d - 1)) & \text{otw.} \end{cases}$$

Note that $T(m, d)$ denotes the **expected running time**.

8 Seidels LP-algorithm

Let C be the largest constant in the \mathcal{O} -notations.

$$T(m, d) = \begin{cases} C \max\{1, m\} & \text{if } d = 1 \\ Cd & \text{if } d > 1 \text{ and } m = 0 \\ Cd + T(m - 1, d) + \\ \frac{d}{m}(Cdm + T(m - 1, d - 1)) & \text{otw.} \end{cases}$$

Note that $T(m, d)$ denotes the **expected running time**.

8 Seidels LP-algorithm

Let C be the largest constant in the \mathcal{O} -notations.

We show $T(m, d) \leq Cf(d) \max\{1, m\}$.

$d = 1$:

$$T(m, 1) \leq C \max\{1, m\} \leq Cf(1) \max\{1, m\} \text{ for } f(1) \geq 1$$

$d > 1; m = 0$:

$$T(0, d) \leq \mathcal{O}(d) \leq Cd \leq Cf(d) \max\{1, m\} \text{ for } f(d) \geq d$$

$d > 1; m = 1$:

$$\begin{aligned} T(1, d) &= \mathcal{O}(d) + T(0, d) + d(\mathcal{O}(d) + T(0, d - 1)) \\ &\leq Cd + Cd + Cd^2 + dCf(d - 1) \\ &\leq Cf(d) \max\{1, m\} \text{ for } f(d) \geq 3d^2 + df(d - 1) \end{aligned}$$

8 Seidels LP-algorithm

$d > 1; m > 1 :$

(by induction hypothesis statm. true for $d' < d, m' \geq 0;$
and for $d' = d, m' < m$)

$$\begin{aligned} T(m, d) &= \mathcal{O}(d) + T(m-1, d) + \frac{d}{m} (\mathcal{O}(dm) + T(m-1, d-1)) \\ &\leq Cd + Cf(d)(m-1) + Cd^2 + \frac{d}{m} Cf(d-1)(m-1) \\ &\leq 2Cd^2 + Cf(d)(m-1) + dCf(d-1) \\ &\leq Cf(d)m \end{aligned}$$

if $f(d) \geq df(d-1) + 2d^2.$

8 Seidels LP-algorithm

- Define $f(1) = 3 \cdot 1^2$ and $f(d) = df(d-1) + 3d^2$ for $d > 1.$

Then

$$\begin{aligned} f(d) &= 3d^2 + df(d-1) \\ &= 3d^2 + d [3(d-1)^2 + (d-1)f(d-2)] \\ &= 3d^2 + d [3(d-1)^2 + (d-1) [3(d-2)^2 + (d-2)f(d-3)]] \\ &= 3d^2 + 3d(d-1)^2 + 3d(d-1)(d-2)^2 + \dots \\ &\quad + 3d(d-1)(d-2) \cdot \dots \cdot 4 \cdot 3 \cdot 2 \cdot 1^2 \\ &= 3d! \left(\frac{d^2}{d!} + \frac{(d-1)^2}{(d-1)!} + \frac{(d-2)^2}{(d-2)!} + \dots \right) \\ &= \mathcal{O}(d!) \end{aligned}$$

since $\sum_{i \geq 1} \frac{i^2}{i!}$ is a constant.

$$\sum_{i \geq 1} \frac{i^2}{i!} = \sum_{i \geq 0} \frac{i+1}{i!} = e + \sum_{i \geq 1} \frac{i}{i!} = 2e$$

Complexity

LP Feasibility Problem (LP feasibility A)

Given $A \in \mathbb{Z}^{m \times n}, b \in \mathbb{Z}^m.$ Does there exist $x \in \mathbb{R}^n$ with $Ax \leq b,$
 $x \geq 0?$

LP Feasibility Problem (LP feasibility B)

Given $A \in \mathbb{Z}^{m \times n}, b \in \mathbb{Z}^m.$ Find $x \in \mathbb{R}^n$ with $Ax \leq b, x \geq 0!$

LP Optimization A

Given $A \in \mathbb{Z}^{m \times n}, b \in \mathbb{Z}^m, c \in \mathbb{Z}^n.$ What is the maximum value of
 $c^T x$ for a feasible point $x \in \mathbb{R}^n?$

LP Optimization B

Given $A \in \mathbb{Z}^{m \times n}, b \in \mathbb{Z}^m, c \in \mathbb{Z}^n.$ Return feasible point $x \in \mathbb{R}^n$
with maximum value of $c^T x?$

Note that allowing A, b to contain rational numbers does not make a difference, as we can multiply every number by a suitable large constant so that everything becomes integral but the feasible region does not change.

The Bit Model

Input size

- The number of bits to represent a number $a \in \mathbb{Z}$ is

$$\lceil \log_2(|a|) \rceil + 1$$

- Let for an $m \times n$ matrix $M, L(M)$ denote the number of bits required to encode all the numbers in $M.$

$$\langle M \rangle := \sum_{i,j} \lceil \log_2(|m_{ij}|) \rceil + 1$$

- In the following we assume that input matrices are encoded in a standard way, where each number is encoded in binary and then suitable separators are added in order to separate distinct number from each other.
- Then the input length is $L = \Theta(\langle A \rangle + \langle b \rangle).$

- ▶ In the following we sometimes refer to $L := \langle A \rangle + \langle b \rangle$ as the input size (even though the real input size is something in $\Theta(\langle A \rangle + \langle b \rangle)$).
- ▶ Sometimes we may also refer to $L := \langle A \rangle + \langle b \rangle + n \log_2 n$ as the input size. Note that $n \log_2 n = \Theta(\langle A \rangle + \langle b \rangle)$.
- ▶ In order to show that LP-decision is in NP we show that if there is a solution x then there exists a small solution for which feasibility can be verified in polynomial time (polynomial in L).

Note that $m \log_2 m$ may be much larger than $\langle A \rangle + \langle b \rangle$.

Suppose that $\bar{A}x = b; x \geq 0$ is feasible.

Then there exists a basic feasible solution. This means a set B of basic variables such that

$$x_B = \bar{A}_B^{-1}b$$

and all other entries in x are 0.

In the following we show that this x has small encoding length and we give an explicit bound on this length. So far we have only been handwaving and have said that we can compute x via Gaussian elimination and it will be short...

Size of a Basic Feasible Solution

Note that n in the theorem denotes the number of columns in A which may be much smaller than m .

- ▶ A : original input matrix
- ▶ \bar{A} : transformation of A into standard form
- ▶ \bar{A}_B : submatrix of \bar{A} corresponding to basis B

Lemma 47

Let $\bar{A}_B \in \mathbb{Z}^{m \times m}$ and $b \in \mathbb{Z}^m$. Define $L = \langle A \rangle + \langle b \rangle + n \log_2 n$. Then a solution to $\bar{A}_B x_B = b$ has rational components x_j of the form $\frac{D_j}{D}$, where $|D_j| \leq 2^L$ and $|D| \leq 2^L$.

Proof:

Cramers rules says that we can compute x_j as

$$x_j = \frac{\det(\bar{A}_B^j)}{\det(\bar{A}_B)}$$

where \bar{A}_B^j is the matrix obtained from \bar{A}_B by replacing the j -th column by the vector b .

Bounding the Determinant

Let $X = \bar{A}_B$. Then

$$\begin{aligned} |\det(X)| &= |\det(\bar{X})| \\ &= \left| \sum_{\pi \in S_{\tilde{n}}} \text{sgn}(\pi) \prod_{1 \leq i \leq \tilde{n}} \bar{X}_{i\pi(i)} \right| \\ &\leq \sum_{\pi \in S_{\tilde{n}}} \prod_{1 \leq i \leq \tilde{n}} |\bar{X}_{i\pi(i)}| \\ &\leq n! \cdot 2^{\langle A \rangle + \langle b \rangle} \leq 2^L \end{aligned}$$

Here \bar{X} is an $\tilde{n} \times \tilde{n}$ submatrix of A with $\tilde{n} \leq n$.

Analogously for $\det(\bar{A}_B^j)$.

When computing the determinant of $X = \bar{A}_B$ we first do expansions along columns that were introduced when transforming A into standard form, i.e., into \bar{A} .

Such a column contains a single 1 and the remaining entries of the column are 0. Therefore, these expansions do not increase the absolute value of the determinant. After we did expansions for all these columns we are left with a square sub-matrix of A of size at most $n \times n$.

Reducing LP-solving to LP decision.

Given an LP $\max\{c^T x \mid Ax \leq b; x \geq 0\}$ do a **binary search** for the optimum solution

(Add constraint $c^T x \geq M$). Then checking for feasibility shows whether optimum solution is larger or smaller than M).

If the LP is feasible then the binary search finishes in at most

$$\log_2 \left(\frac{2n2^{2L'}}{1/2^{L'}} \right) = \mathcal{O}(L') ,$$

as the range of the search is at most $-n2^{2L'}, \dots, n2^{2L'}$ and the distance between two adjacent values is at least $\frac{1}{\det(A)} \geq \frac{1}{2^{L'}}$.

Here we use $L' = \langle A \rangle + \langle b \rangle + \langle c \rangle + n \log_2 n$ (it also includes the encoding size of c).

How do we detect whether the LP is unbounded?

Let $M_{\max} = n2^{2L'}$ be an upper bound on the objective value of a **basic feasible solution**.

We can add a constraint $c^T x \geq M_{\max} + 1$ and check for feasibility.

Ellipsoid Method

- ▶ Let K be a convex set.
- ▶ Maintain ellipsoid E that is guaranteed to contain K provided that K is non-empty.
- ▶ If center $z \in K$ STOP.
- ▶ Otw. find a hyperplane separating K from z (e.g. a violated constraint in the LP).
- ▶ Shift hyperplane to contain node z . H denotes half-space that contains K .
- ▶ Compute (smallest) ellipsoid E' that contains $E \cap H$.
- ▶ REPEAT

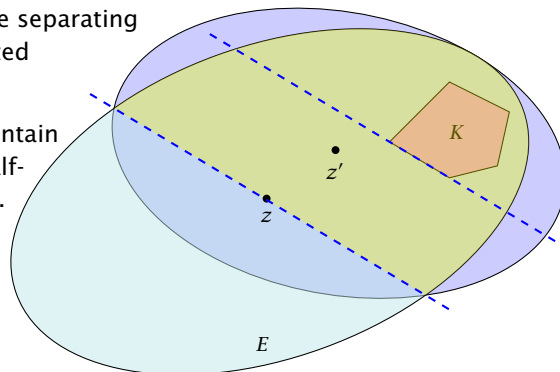

Issues/Questions:

- ▶ How do you choose the first Ellipsoid? What is its volume?
- ▶ How do you measure progress? By how much does the volume decrease in each iteration?
- ▶ When can you stop? What is the minimum volume of a non-empty polytop?

Definition 48

A mapping $f: \mathbb{R}^n \rightarrow \mathbb{R}^n$ with $f(x) = Lx + t$, where L is an invertible matrix is called an **affine transformation**.

Definition 49

A ball in \mathbb{R}^n with center c and radius r is given by

$$\begin{aligned} B(c, r) &= \{x \mid (x - c)^T(x - c) \leq r^2\} \\ &= \{x \mid \sum_i (x - c)_i^2 / r^2 \leq 1\} \end{aligned}$$

$B(0, 1)$ is called the **unit ball**.

Definition 50

An affine transformation of the unit ball is called an **ellipsoid**.

From $f(x) = Lx + t$ follows $x = L^{-1}(f(x) - t)$.

$$\begin{aligned} f(B(0, 1)) &= \{f(x) \mid x \in B(0, 1)\} \\ &= \{y \in \mathbb{R}^n \mid L^{-1}(y - t) \in B(0, 1)\} \\ &= \{y \in \mathbb{R}^n \mid (y - t)^T L^{-1T} L^{-1} (y - t) \leq 1\} \\ &= \{y \in \mathbb{R}^n \mid (y - t)^T Q^{-1} (y - t) \leq 1\} \end{aligned}$$

where $Q = LL^T$ is an invertible matrix.

How to Compute the New Ellipsoid

- ▶ Use f^{-1} (recall that $f = Lx + t$ is the affine transformation of the unit ball) to rotate/distort the ellipsoid (back) into the unit ball.
- ▶ Use a rotation R^{-1} to rotate the unit ball such that the normal vector of the halfspace is parallel to e_1 .
- ▶ Compute the new center \hat{c}' and the new matrix \hat{Q}' for this simplified setting.
- ▶ Use the transformations R and f to get the new center c' and the new matrix Q' for the original ellipsoid E .

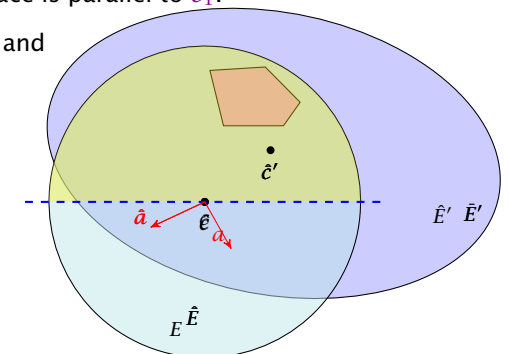

The Easy Case

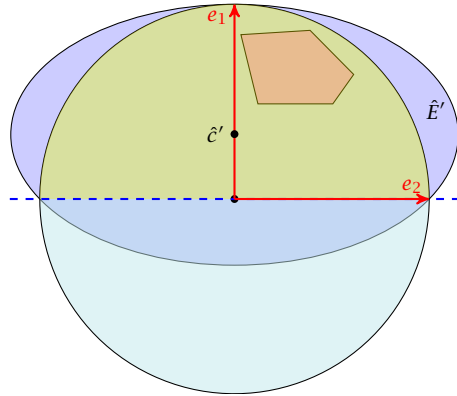

- ▶ The new center lies on axis x_1 . Hence, $\hat{c}' = te_1$ for $t > 0$.
- ▶ The vectors e_1, e_2, \dots have to fulfill the ellipsoid constraint with equality. Hence $(e_i - \hat{c}')^T \hat{Q}'^{-1} (e_i - \hat{c}') = 1$.

The Easy Case

- ▶ To obtain the matrix \hat{Q}'^{-1} for our ellipsoid \hat{E}' note that \hat{E}' is axis-parallel.
- ▶ Let a denote the radius along the x_1 -axis and let b denote the (common) radius for the other axes.
- ▶ The matrix

$$\hat{L}' = \begin{pmatrix} a & 0 & \dots & 0 \\ 0 & b & \ddots & \vdots \\ \vdots & \ddots & \ddots & 0 \\ 0 & \dots & 0 & b \end{pmatrix}$$

maps the unit ball (via function $\hat{f}'(x) = \hat{L}'x$) to an axis-parallel ellipsoid with radius a in direction x_1 and b in all other directions.

The Easy Case

- ▶ As $\hat{Q}' = \hat{L}'\hat{L}'^t$ the matrix \hat{Q}'^{-1} is of the form

$$\hat{Q}'^{-1} = \begin{pmatrix} \frac{1}{a^2} & 0 & \dots & 0 \\ 0 & \frac{1}{b^2} & \ddots & \vdots \\ \vdots & \ddots & \ddots & 0 \\ 0 & \dots & 0 & \frac{1}{b^2} \end{pmatrix}$$

The Easy Case

- ▶ $(e_1 - \hat{c}')^T \hat{Q}'^{-1} (e_1 - \hat{c}') = 1$ gives

$$\begin{pmatrix} 1-t \\ 0 \\ \vdots \\ 0 \end{pmatrix}^T \cdot \begin{pmatrix} \frac{1}{a^2} & 0 & \dots & 0 \\ 0 & \frac{1}{b^2} & \ddots & \vdots \\ \vdots & \ddots & \ddots & 0 \\ 0 & \dots & 0 & \frac{1}{b^2} \end{pmatrix} \cdot \begin{pmatrix} 1-t \\ 0 \\ \vdots \\ 0 \end{pmatrix} = 1$$

- ▶ This gives $(1-t)^2 = a^2$.

The Easy Case

- ▶ For $i \neq 1$ the equation $(e_i - \hat{c}')^T \hat{Q}'^{-1} (e_i - \hat{c}') = 1$ looks like (here $i = 2$)

$$\begin{pmatrix} -t \\ 1 \\ 0 \\ \vdots \\ 0 \end{pmatrix}^T \cdot \begin{pmatrix} \frac{1}{a^2} & 0 & \dots & 0 \\ 0 & \frac{1}{b^2} & \ddots & \vdots \\ \vdots & \ddots & \ddots & 0 \\ 0 & \dots & 0 & \frac{1}{b^2} \end{pmatrix} \cdot \begin{pmatrix} -t \\ 1 \\ 0 \\ \vdots \\ 0 \end{pmatrix} = 1$$

- ▶ This gives $\frac{t^2}{a^2} + \frac{1}{b^2} = 1$, and hence

$$\frac{1}{b^2} = 1 - \frac{t^2}{a^2} = 1 - \frac{t^2}{(1-t)^2} = \frac{1-2t}{(1-t)^2}$$

Summary

So far we have

$$a = 1 - t \quad \text{and} \quad b = \frac{1-t}{\sqrt{1-2t}}$$

The Easy Case

We still have many choices for t :

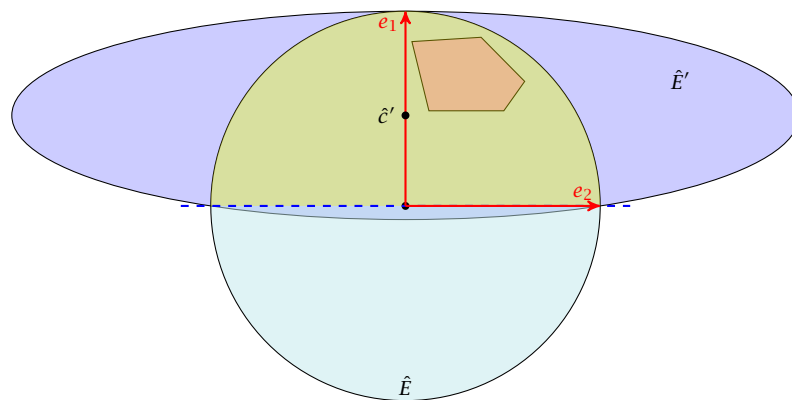

Choose t such that the volume of \hat{E}' is minimal!!!

The Easy Case

We want to choose t such that the volume of \hat{E}' is minimal.

Lemma 51

Let L be an affine transformation and $K \subseteq \mathbb{R}^n$. Then

$$\text{vol}(L(K)) = |\det(L)| \cdot \text{vol}(K) .$$

n-dimensional volume

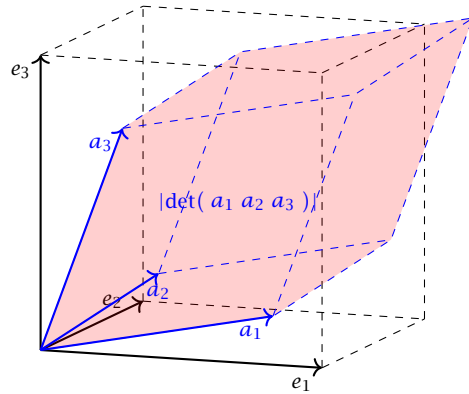

The Easy Case

- ▶ We want to choose t such that the volume of \hat{E}' is minimal.

$$\text{vol}(\hat{E}') = \text{vol}(B(0,1)) \cdot |\det(\hat{L}')| ,$$

- ▶ Recall that

$$\hat{L}' = \begin{pmatrix} a & 0 & \dots & 0 \\ 0 & b & \ddots & \vdots \\ \vdots & \ddots & \ddots & 0 \\ 0 & \dots & 0 & b \end{pmatrix}$$

- ▶ Note that a and b in the above equations depend on t , by the previous equations.

The Easy Case

$$\begin{aligned} \text{vol}(\hat{E}') &= \text{vol}(B(0,1)) \cdot |\det(\hat{L}')| \\ &= \text{vol}(B(0,1)) \cdot ab^{n-1} \\ &= \text{vol}(B(0,1)) \cdot (1-t) \cdot \left(\frac{1-t}{\sqrt{1-2t}}\right)^{n-1} \\ &= \text{vol}(B(0,1)) \cdot \frac{(1-t)^n}{(\sqrt{1-2t})^{n-1}} \end{aligned}$$

We use the shortcut $\Phi := \text{vol}(B(0,1))$.

The Easy Case

$$\begin{aligned} \frac{d \text{vol}(\hat{E}')}{dt} &= \frac{d}{dt} \left(\Phi \frac{(1-t)^n}{(\sqrt{1-2t})^{n-1}} \right) \\ &= \frac{\Phi}{N^2} \cdot \left(\underbrace{(-1) \cdot n(1-t)^{n-1}}_{\text{derivative of numerator}} \cdot \underbrace{(\sqrt{1-2t})^{n-1}}_{\text{denominator}} \right. \\ &\quad \left. - \underbrace{(n-1)(\sqrt{1-2t})^{n-2}}_{\text{outer derivative}} \cdot \underbrace{\frac{1}{2\sqrt{1-2t}}}_{\text{inner derivative}} \cdot \underbrace{(1-t)^n}_{\text{numerator}} \right) \\ &= \frac{\Phi}{N^2} \cdot (\sqrt{1-2t})^{n-3} \cdot (1-t)^{n-1} \cdot \left((n-1)(1-t) - n(1-2t) \right) \\ &= \frac{\Phi}{N^2} \cdot (\sqrt{1-2t})^{n-3} \cdot (1-t)^{n-1} \cdot \left((n+1)t - 1 \right) \end{aligned}$$

The Easy Case

- ▶ We obtain the minimum for $t = \frac{1}{n+1}$.
- ▶ For this value we obtain

$$a = 1 - t = \frac{n}{n+1} \text{ and } b = \frac{1-t}{\sqrt{1-2t}} = \frac{n}{\sqrt{n^2-1}}$$

To see the equation for b , observe that

$$b^2 = \frac{(1-t)^2}{1-2t} = \frac{(1-\frac{1}{n+1})^2}{1-\frac{2}{n+1}} = \frac{(\frac{n}{n+1})^2}{\frac{n-1}{n+1}} = \frac{n^2}{n^2-1}$$

The Easy Case

Let $\gamma_n = \frac{\text{vol}(\hat{E}')}{\text{vol}(B(0,1))} = ab^{n-1}$ be the ratio by which the volume changes:

$$\begin{aligned} \gamma_n^2 &= \left(\frac{n}{n+1}\right)^2 \left(\frac{n^2}{n^2-1}\right)^{n-1} \\ &= \left(1 - \frac{1}{n+1}\right)^2 \left(1 + \frac{1}{(n-1)(n+1)}\right)^{n-1} \\ &\leq e^{-2\frac{1}{n+1}} \cdot e^{\frac{1}{n+1}} \\ &= e^{-\frac{1}{n+1}} \end{aligned}$$

where we used $(1+x)^a \leq e^{ax}$ for $x \in \mathbb{R}$ and $a > 0$.

This gives $\gamma_n \leq e^{-\frac{1}{2(n+1)}}$.

How to Compute the New Ellipsoid

- ▶ Use f^{-1} (recall that $f = Lx + t$ is the affine transformation of the unit ball) to translate/distort the ellipsoid (back) into the unit ball.
- ▶ Use a rotation R^{-1} to rotate the unit ball such that the normal vector of the halfspace is parallel to e_1 .
- ▶ Compute the new center \hat{c}' and the new matrix \hat{Q}' for this simplified setting.
- ▶ Use the transformations R and f to get the new center c' and the new matrix Q' for the original ellipsoid E .

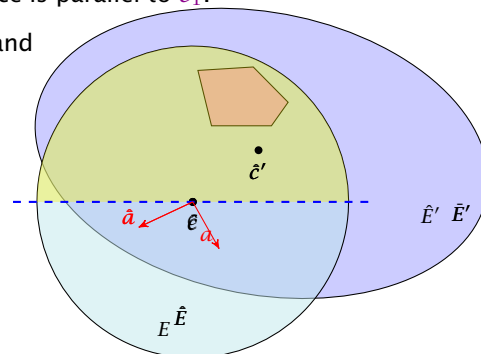

Our progress is the same:

$$\begin{aligned} e^{-\frac{1}{2(n+1)}} &\geq \frac{\text{vol}(\hat{E}')}{\text{vol}(B(0,1))} = \frac{\text{vol}(\hat{E}')}{\text{vol}(\hat{E})} = \frac{\text{vol}(R(\hat{E}'))}{\text{vol}(R(\hat{E}))} \\ &= \frac{\text{vol}(\hat{E}')}{\text{vol}(\hat{E})} = \frac{\text{vol}(f(\hat{E}'))}{\text{vol}(f(\hat{E}))} = \frac{\text{vol}(E')}{\text{vol}(E)} \end{aligned}$$

Here it is important that mapping a set with affine function $f(x) = Lx + t$ changes the volume by factor $\det(L)$.

The Ellipsoid Algorithm

How to compute the new parameters?

The transformation function of the (old) ellipsoid: $f(x) = Lx + c$;

The halfspace to be intersected: $H = \{x \mid a^T(x - c) \leq 0\}$;

$$\begin{aligned} f^{-1}(H) &= \{f^{-1}(x) \mid a^T(x - c) \leq 0\} \\ &= \{f^{-1}(f(y)) \mid a^T(f(y) - c) \leq 0\} \\ &= \{y \mid a^T(f(y) - c) \leq 0\} \\ &= \{y \mid a^T(Ly + c - c) \leq 0\} \\ &= \{y \mid (a^T L)y \leq 0\} \end{aligned}$$

This means $\bar{a} = L^T a$.

The center \bar{c} is of course at the origin.

The Ellipsoid Algorithm

After rotating back (applying R^{-1}) the normal vector of the halfspace points in negative x_1 -direction. Hence,

$$R^{-1}\left(\frac{L^T a}{\|L^T a\|}\right) = -e_1 \Rightarrow -\frac{L^T a}{\|L^T a\|} = R \cdot e_1$$

Hence,

$$\bar{c}' = R \cdot \hat{c}' = R \cdot \frac{1}{n+1} e_1 = -\frac{1}{n+1} \frac{L^T a}{\|L^T a\|}$$

$$\begin{aligned} c' &= f(\bar{c}') = L \cdot \bar{c}' + c \\ &= -\frac{1}{n+1} L \frac{L^T a}{\|L^T a\|} + c \\ &= c - \frac{1}{n+1} \frac{Qa}{\sqrt{a^T Q a}} \end{aligned}$$

For computing the matrix Q' of the new ellipsoid we assume in the following that \hat{E}', \bar{E}' and E' refer to the ellipsoids centered in the origin.

Recall that

$$\hat{Q}' = \begin{pmatrix} a^2 & 0 & \dots & 0 \\ 0 & b^2 & \ddots & \vdots \\ \vdots & \ddots & \ddots & 0 \\ 0 & \dots & 0 & b^2 \end{pmatrix}$$

This gives

$$\hat{Q}' = \frac{n^2}{n^2 - 1} \left(I - \frac{2}{n+1} e_1 e_1^T \right)$$

Note that $e_1 e_1^T$ is a matrix M that has $M_{11} = 1$ and all other entries equal to 0.

because for $a^2 = n^2/(n+1)^2$ and $b^2 = n^2/n^2 - 1$

$$\begin{aligned} b^2 - b^2 \frac{2}{n+1} &= \frac{n^2}{n^2 - 1} - \frac{2n^2}{(n-1)(n+1)^2} \\ &= \frac{n^2(n+1) - 2n^2}{(n-1)(n+1)^2} = \frac{n^2(n-1)}{(n-1)(n+1)^2} = a^2 \end{aligned}$$

9 The Ellipsoid Algorithm

$$\begin{aligned}
 \tilde{E}' &= R(\hat{E}') \\
 &= \{R(x) \mid x^T \hat{Q}'^{-1} x \leq 1\} \\
 &= \{y \mid (R^{-1}y)^T \hat{Q}'^{-1} R^{-1}y \leq 1\} \\
 &= \{y \mid y^T (R^T)^{-1} \hat{Q}'^{-1} R^{-1}y \leq 1\} \\
 &= \{y \mid y^T \underbrace{(R \hat{Q}' R^T)^{-1}}_{\tilde{Q}'} y \leq 1\}
 \end{aligned}$$

9 The Ellipsoid Algorithm

Hence,

$$\begin{aligned}
 \tilde{Q}' &= R \hat{Q}' R^T \\
 &= R \cdot \frac{n^2}{n^2-1} \left(I - \frac{2}{n+1} e_1 e_1^T \right) \cdot R^T \\
 &= \frac{n^2}{n^2-1} \left(R \cdot R^T - \frac{2}{n+1} (R e_1)(R e_1)^T \right) \\
 &= \frac{n^2}{n^2-1} \left(I - \frac{2}{n+1} \frac{L^T a a^T L}{\|L^T a\|^2} \right)
 \end{aligned}$$

Here we used the equation for $R e_1$ proved before, and the fact that $R R^T = I$, which holds for any rotation matrix. To see this observe that the length of a rotated vector x should not change, i.e.,

$$x^T I x = (R x)^T (R x) = x^T (R^T R) x$$

which means $x^T (I - R^T R) x = 0$ for every vector x . It is easy to see that this can only be fulfilled if $I - R^T R = 0$.

9 The Ellipsoid Algorithm

$$\begin{aligned}
 E' &= L(\tilde{E}') \\
 &= \{L(x) \mid x^T \tilde{Q}'^{-1} x \leq 1\} \\
 &= \{y \mid (L^{-1}y)^T \tilde{Q}'^{-1} L^{-1}y \leq 1\} \\
 &= \{y \mid y^T (L^T)^{-1} \tilde{Q}'^{-1} L^{-1}y \leq 1\} \\
 &= \{y \mid y^T \underbrace{(L \tilde{Q}' L^T)^{-1}}_{Q'} y \leq 1\}
 \end{aligned}$$

9 The Ellipsoid Algorithm

Hence,

$$\begin{aligned}
 Q' &= L \tilde{Q}' L^T \\
 &= L \cdot \frac{n^2}{n^2-1} \left(I - \frac{2}{n+1} \frac{L^T a a^T L}{a^T Q a} \right) \cdot L^T \\
 &= \frac{n^2}{n^2-1} \left(Q - \frac{2}{n+1} \frac{Q a a^T Q}{a^T Q a} \right)
 \end{aligned}$$

Incomplete Algorithm

Algorithm 1 ellipsoid-algorithm

```
1: input: point  $c \in \mathbb{R}^n$ , convex set  $K \subseteq \mathbb{R}^n$ 
2: output: point  $x \in K$  or “ $K$  is empty”
3:  $Q \leftarrow ???$ 
4: repeat
5:   if  $c \in K$  then return  $c$ 
6:   else
7:     choose a violated hyperplane  $a$ 
8:      $c \leftarrow c - \frac{1}{n+1} \frac{Qa}{\sqrt{a^T Q a}}$ 
9:      $Q \leftarrow \frac{n^2}{n^2-1} \left( Q - \frac{2}{n+1} \frac{Qaa^T Q}{a^T Q a} \right)$ 
10:  endif
11: until ???
12: return “ $K$  is empty”
```

Repeat: Size of basic solutions

Lemma 52

Let $P = \{x \in \mathbb{R}^n \mid Ax \leq b\}$ be a bounded polyhedron. Let $L := 2\langle A \rangle + \langle b \rangle + 2n(1 + \log_2 n)$. Then every entry x_j in a basic solution fulfills $|x_j| = \frac{D_j}{D}$ with $D_j, D \leq 2^L$.

In the following we use $\delta := 2^L$.

Proof:

We can replace P by $P' := \{x \mid A'x \leq b; x \geq 0\}$ where $A' = \begin{bmatrix} A & -A \end{bmatrix}$. The lemma follows by applying Lemma 47, and observing that $\langle A' \rangle = 2\langle A \rangle$ and $n' = 2n$.

How do we find the first ellipsoid?

For feasibility checking we can assume that the polytop P is bounded; it is sufficient to consider basic solutions.

Every entry x_i in a basic solution fulfills $|x_i| \leq \delta$.

Hence, P is contained in the cube $-\delta \leq x_i \leq \delta$.

A vector in this cube has at most distance $R := \sqrt{n}\delta$ from the origin.

Starting with the ball $E_0 := B(0, R)$ ensures that P is completely contained in the initial ellipsoid. This ellipsoid has volume at most $R^n \text{vol}(B(0, 1)) \leq (n\delta)^n \text{vol}(B(0, 1))$.

When can we terminate?

Let $P := \{x \mid Ax \leq b\}$ with $A \in \mathbb{Z}$ and $b \in \mathbb{Z}$ be a bounded polytop.

Consider the following polyhedron

$$P_\lambda := \left\{ x \mid Ax \leq b + \frac{1}{\lambda} \begin{pmatrix} 1 \\ \vdots \\ 1 \end{pmatrix} \right\},$$

where $\lambda = \delta^2 + 1$.

Note that the volume of P_λ cannot be 0

Making P full-dimensional

Lemma 53

P_λ is feasible if and only if P is feasible.

\Leftarrow : obvious!

Making P full-dimensional

\Rightarrow :

Consider the polyhedrons

$$\bar{P} = \{x \mid [A \ -A \ I_m]x = b; x \geq 0\}$$

and

$$\bar{P}_\lambda = \left\{x \mid [A \ -A \ I_m]x = b + \frac{1}{\lambda} \begin{pmatrix} 1 \\ \vdots \\ 1 \end{pmatrix}; x \geq 0\right\}.$$

P is feasible if and only if \bar{P} is feasible, and P_λ feasible if and only if \bar{P}_λ feasible.

\bar{P}_λ is bounded since P_λ and P are bounded.

Making P full-dimensional

Let $\bar{A} = [A \ -A \ I_m]$.

\bar{P}_λ feasible implies that there is a basic feasible solution represented by

$$x_B = \bar{A}_B^{-1}b + \frac{1}{\lambda}\bar{A}_B^{-1} \begin{pmatrix} 1 \\ \vdots \\ 1 \end{pmatrix}$$

(The other x -values are zero)

The only reason that this basic feasible solution is not feasible for \bar{P} is that one of the basic variables becomes negative.

Hence, there exists i with

$$(\bar{A}_B^{-1}b)_i < 0 \leq (\bar{A}_B^{-1}b)_i + \frac{1}{\lambda}(\bar{A}_B^{-1}\bar{1})_i$$

Making P full-dimensional

By Cramers rule we get

$$(\bar{A}_B^{-1}b)_i < 0 \Rightarrow (\bar{A}_B^{-1}b)_i \leq -\frac{1}{\det(\bar{A}_B)} \leq -1/\delta$$

and

$$(\bar{A}_B^{-1}\bar{1})_i \leq \det(\bar{A}_B^j) \leq \delta,$$

where \bar{A}_B^j is obtained by replacing the j -th column of \bar{A}_B by $\bar{1}$.

But then

$$(\bar{A}_B^{-1}b)_i + \frac{1}{\lambda}(\bar{A}_B^{-1}\bar{1})_i \leq -1/\delta + \delta/\lambda < 0,$$

as we chose $\lambda = \delta^2 + 1$. Contradiction.

Lemma 54

If P_λ is feasible then it contains a ball of radius $r := 1/\delta^3$. This has a volume of at least $r^n \text{vol}(B(0, 1)) = \frac{1}{\delta^{3n}} \text{vol}(B(0, 1))$.

Proof:

If P_λ feasible then also P . Let x be feasible for P .

This means $Ax \leq b$.

Let $\vec{\ell}$ with $\|\vec{\ell}\| \leq r$. Then

$$\begin{aligned}(A(x + \vec{\ell}))_i &= (Ax)_i + (A\vec{\ell})_i \leq b_i + \vec{a}_i^T \vec{\ell} \\ &\leq b_i + \|\vec{a}_i\| \cdot \|\vec{\ell}\| \leq b_i + \sqrt{n} \cdot 2^{(a_{\max})} \cdot r \\ &\leq b_i + \frac{\sqrt{n} \cdot 2^{(a_{\max})}}{\delta^3} \leq b_i + \frac{1}{\delta^2 + 1} \leq b_i + \frac{1}{\lambda}\end{aligned}$$

Hence, $x + \vec{\ell}$ is feasible for P_λ which proves the lemma.

How many iterations do we need until the volume becomes too small?

$$e^{-\frac{i}{2(n+1)}} \cdot \text{vol}(B(0, R)) < \text{vol}(B(0, r))$$

Hence,

$$\begin{aligned}i &> 2(n+1) \ln \left(\frac{\text{vol}(B(0, R))}{\text{vol}(B(0, r))} \right) \\ &= 2(n+1) \ln (n^n \delta^n \cdot \delta^{3n}) \\ &= 8n(n+1) \ln(\delta) + 2(n+1)n \ln(n) \\ &= \mathcal{O}(\text{poly}(n) \cdot L)\end{aligned}$$

Algorithm 1 ellipsoid-algorithm

```
1: input: point  $c \in \mathbb{R}^n$ , convex set  $K \subseteq \mathbb{R}^n$ , radii  $R$  and  $r$ 
2:   with  $K \subseteq B(c, R)$ , and  $B(x, r) \subseteq K$  for some  $x$ 
3: output: point  $x \in K$  or "K is empty"
4:  $Q \leftarrow \text{diag}(R^2, \dots, R^2)$  // i.e.,  $L = \text{diag}(R, \dots, R)$ 
5: repeat
6:   if  $c \in K$  then return  $c$ 
7:   else
8:     choose a violated hyperplane  $a$ 
9:      $c \leftarrow c - \frac{1}{n+1} \frac{Qa}{\sqrt{a^T Q a}}$ 
10:     $Q \leftarrow \frac{n^2}{n^2-1} \left( Q - \frac{2}{n+1} \frac{Qaa^T Q}{a^T Q a} \right)$ 
11:   endif
12: until  $\det(Q) \leq r^{2n}$  // i.e.,  $\det(L) \leq r^n$ 
13: return "K is empty"
```

Separation Oracle

Let $K \subseteq \mathbb{R}^n$ be a convex set. A separation oracle for K is an algorithm A that gets as input a point $x \in \mathbb{R}^n$ and either

- ▶ certifies that $x \in K$,
- ▶ or finds a hyperplane separating x from K .

We will usually assume that A is a polynomial-time algorithm.

In order to find a point in K we need

- ▶ a guarantee that a ball of radius r is contained in K ,
- ▶ an initial ball $B(c, R)$ with radius R that contains K ,
- ▶ a separation oracle for K .

The Ellipsoid algorithm requires $\mathcal{O}(\text{poly}(n) \cdot \log(R/r))$ iterations. Each iteration is polytime for a polynomial-time Separation oracle.

Example

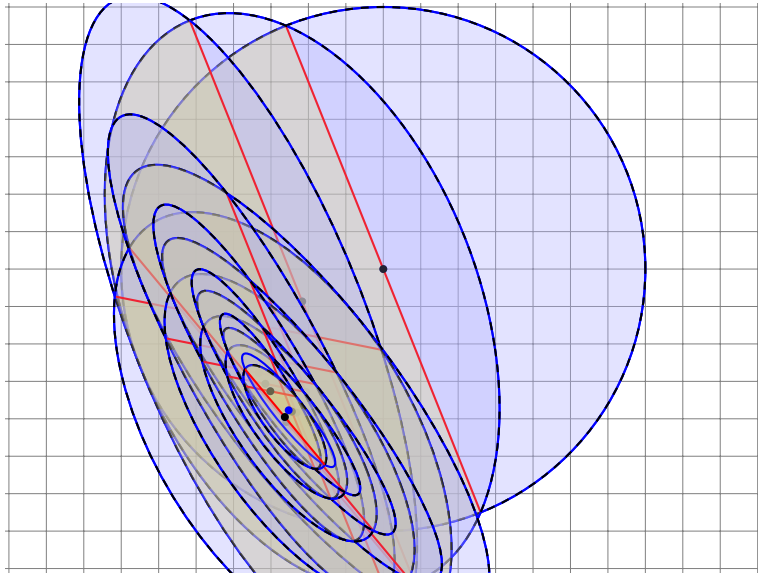

10 Karmarkars Algorithm

- ▶ inequalities $Ax \leq b$; $m \times n$ matrix A with rows a_i^T
- ▶ $P = \{x \mid Ax \leq b\}$; $P^\circ := \{x \mid Ax < b\}$
- ▶ interior point algorithm: $x \in P^\circ$ throughout the algorithm
- ▶ for $x \in P^\circ$ define

$$s_i(x) := b_i - a_i^T x$$

as the **slack** of the i -th constraint

logarithmic barrier function:

$$\phi(x) = - \sum_{i=1}^m \ln(s_i(x))$$

Penalty for point x ; points close to the boundary have a very large penalty.

Throughout this section a_i denotes the i -th row as a column vector.

Penalty Function

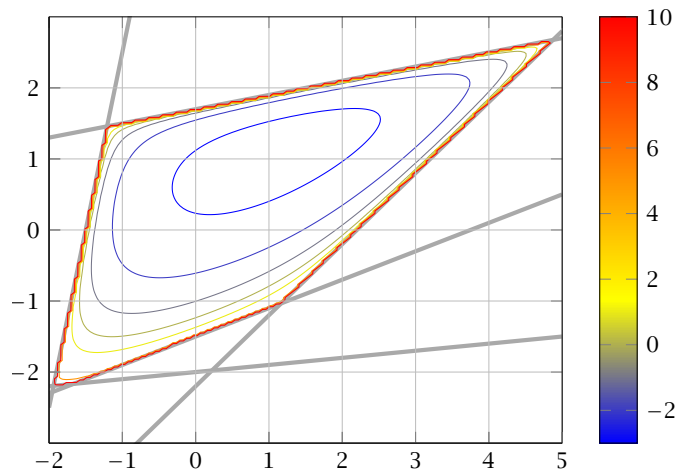

Penalty Function

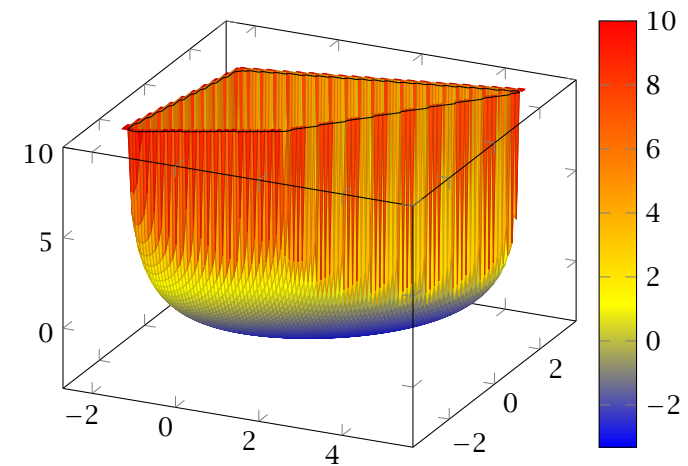

Gradient and Hessian

Taylor approximation:

$$\phi(x + \epsilon) \approx \phi(x) + \nabla \phi(x)^T \epsilon + \frac{1}{2} \epsilon^T \nabla^2 \phi(x) \epsilon$$

Gradient:

$$\nabla \phi(x) = \sum_{i=1}^m \frac{1}{s_i(x)} \cdot a_i = A^T d_x$$

where $d_x^T = (1/s_1(x), \dots, 1/s_m(x))$. (d_x vector of **inverse slacks**)

Hessian:

$$H_x := \nabla^2 \phi(x) = \sum_{i=1}^m \frac{1}{s_i(x)^2} a_i a_i^T = A^T D_x^2 A$$

with $D_x = \text{diag}(d_x)$.

Proof for Gradient

$$\begin{aligned} \frac{\partial \phi(x)}{\partial x_i} &= \frac{\partial}{\partial x_i} \left(- \sum_r \ln(s_r(x)) \right) \\ &= - \sum_r \frac{\partial}{\partial x_i} \left(\ln(s_r(x)) \right) = - \sum_r \frac{1}{s_r(x)} \frac{\partial}{\partial x_i} (s_r(x)) \\ &= - \sum_r \frac{1}{s_r(x)} \frac{\partial}{\partial x_i} (b_r - a_r^T x) = \sum_r \frac{1}{s_r(x)} \frac{\partial}{\partial x_i} (a_r^T x) \\ &= \sum_r \frac{1}{s_r(x)} A_{ri} \end{aligned}$$

The i -th entry of the gradient vector is $\sum_r 1/s_r(x) \cdot A_{ri}$. This gives that the gradient is

$$\nabla \phi(x) = \sum_r 1/s_r(x) a_r = A^T d_x$$

Proof for Hessian

$$\begin{aligned} \frac{\partial}{\partial x_j} \left(\sum_r \frac{1}{s_r(x)} A_{ri} \right) &= \sum_r A_{ri} \left(- \frac{1}{s_r(x)^2} \right) \cdot \frac{\partial}{\partial x_j} (s_r(x)) \\ &= \sum_r A_{ri} \frac{1}{s_r(x)^2} A_{rj} \end{aligned}$$

Note that $\sum_r A_{ri} A_{rj} = (A^T A)_{ij}$. Adding the additional factors $1/s_r(x)^2$ can be done with a diagonal matrix.

Hence the Hessian is

$$H_x = A^T D_x^2 A$$

Properties of the Hessian

H_x is positive semi-definite for $x \in P^\circ$

$$u^T H_x u = u^T A^T D_x^2 A u = \|D_x A u\|_2^2 \geq 0$$

This gives that $\phi(x)$ is convex.

If $\text{rank}(A) = n$, H_x is positive definite for $x \in P^\circ$

$$u^T H_x u = \|D_x A u\|_2^2 > 0 \text{ for } u \neq 0$$

This gives that $\phi(x)$ is **strictly** convex.

$\|u\|_{H_x} := \sqrt{u^T H_x u}$ is a (semi-)norm; the unit ball w.r.t. this norm is an ellipsoid.

Dikin Ellipsoid

$$E_x = \{y \mid (y - x)^T H_x (y - x) \leq 1\} = \{y \mid \|y - x\|_{H_x} \leq 1\}$$

Points in E_x are feasible!!!

$$\begin{aligned} (y - x)^T H_x (y - x) &= (y - x)^T A^T D_x^2 A (y - x) \\ &= \sum_{i=1}^m \frac{(a_i^T (y - x))^2}{s_i(x)^2} \\ &= \sum_{i=1}^m \frac{(\text{change of distance to } i\text{-th constraint going from } x \text{ to } y)^2}{(\text{distance of } x \text{ to } i\text{-th constraint})^2} \\ &\leq 1 \end{aligned}$$

In order to become infeasible when going from x to y one of the terms in the sum would need to be larger than 1.

Dikin Ellipsoids

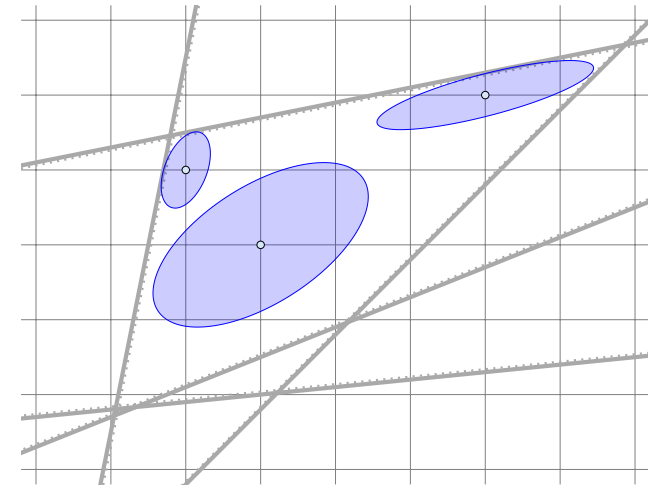

Analytic Center

$$x_{ac} := \arg \min_{x \in P^\circ} \phi(x)$$

► x_{ac} is solution to

$$\nabla \phi(x) = \sum_{i=1}^m \frac{1}{s_i(x)} a_i = 0$$

- depends on the **description** of the polytope
- x_{ac} exists and is unique iff P° is nonempty and bounded

Central Path

In the following we assume that the LP and its dual are **strictly feasible** and that $\text{rank}(A) = n$.

Central Path:

Set of points $\{x^*(t) \mid t > 0\}$ with

$$x^*(t) = \arg \min_x \{t c^T x + \phi(x)\}$$

- $t = 0$: analytic center
- $t = \infty$: optimum solution

$x^*(t)$ exists and is unique for all $t \geq 0$.

Different Central Paths

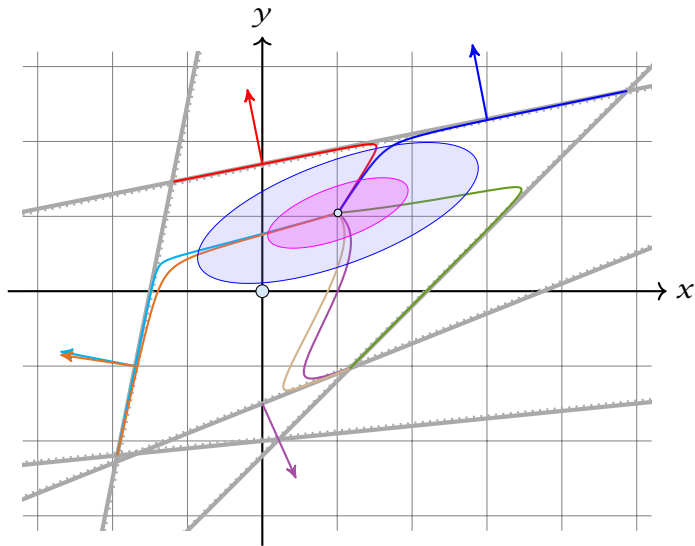

Central Path

Intuitive Idea:

Find point on central path for large value of t . Should be close to optimum solution.

Questions:

- ▶ Is this really true? How large a t do we need?
- ▶ How do we find corresponding point $x^*(t)$ on central path?

The Dual

primal-dual pair:

$$\begin{aligned} \min \quad & c^T x \\ \text{s.t.} \quad & Ax \leq b \end{aligned}$$

$$\begin{aligned} \max \quad & -b^T z \\ \text{s.t.} \quad & A^T z + c = 0 \\ & z \geq 0 \end{aligned}$$

Assumptions

- ▶ primal and dual problems are strictly feasible;
- ▶ $\text{rank}(A) = n$.

Note that the right LP in standard form is equal to $\max\{-b^T y \mid -A^T y = c, y \geq 0\}$. The dual of this is $\min\{c^T x \mid -Ax \geq -b\}$ (variables x are unrestricted).

Force Field Interpretation

Point $x^*(t)$ on central path is solution to $tc + \nabla\phi(x) = 0$

- ▶ We can view each constraint as generating a repelling force. The combination of these forces is represented by $\nabla\phi(x)$.
- ▶ In addition there is a force tc pulling us towards the optimum solution.

How large should t be?

Point $x^*(t)$ on central path is solution to $tc + \nabla\phi(x) = 0$.

This means

$$tc + \sum_{i=1}^m \frac{1}{s_i(x^*(t))} a_i = 0$$

or

$$c + \sum_{i=1}^m z_i^*(t) a_i = 0 \text{ with } z_i^*(t) = \frac{1}{ts_i(x^*(t))}$$

- ▶ $z^*(t)$ is strictly dual feasible: ($A^T z^* + c = 0$; $z^* > 0$)
- ▶ duality gap between $x := x^*(t)$ and $z := z^*(t)$ is

$$c^T x + b^T z = (b - Ax)^T z = \frac{m}{t}$$

- ▶ if gap is less than $1/2^{\Omega(L)}$ we can snap to optimum point

How to find $x^*(t)$

First idea:

- ▶ start somewhere in the polytope
- ▶ use iterative method (**Newtons method**) to minimize $f_t(x) := tc^T x + \phi(x)$

Newton Method

Quadratic approximation of f_t

$$f_t(x + \epsilon) \approx f_t(x) + \nabla f_t(x)^T \epsilon + \frac{1}{2} \epsilon^T H_{f_t}(x) \epsilon$$

Suppose this were exact:

$$f_t(x + \epsilon) = f_t(x) + \nabla f_t(x)^T \epsilon + \frac{1}{2} \epsilon^T H_{f_t}(x) \epsilon$$

Then gradient is given by:

$$\nabla f_t(x + \epsilon) = \nabla f_t(x) + H_{f_t}(x) \cdot \epsilon$$

Note that for the one-dimensional case $g(\epsilon) = f(x) + f'(x)\epsilon + \frac{1}{2}f''(x)\epsilon^2$, then $g'(\epsilon) = f'(x) + f''(x)\epsilon$.

Newton Method

Observe that $H_{f_t}(x) = H(x)$, where $H(x)$ is the Hessian for the function $\phi(x)$ (adding a linear term like $tc^T x$ does not affect the Hessian).

Also $\nabla f_t(x) = tc + \nabla\phi(x)$.

We want to move to a point where this gradient is 0:

Newton Step at $x \in P^\circ$

$$\begin{aligned} \Delta x_{nt} &= -H_{f_t}^{-1}(x) \nabla f_t(x) \\ &= -H_{f_t}^{-1}(x) (tc + \nabla\phi(x)) \\ &= -(A^T D_x^2 A)^{-1} (tc + A^T d_x) \end{aligned}$$

Newton Iteration:

$$x := x + \Delta x_{nt}$$

Measuring Progress of Newton Step

Newton decrement:

$$\begin{aligned}\lambda_t(x) &= \|D_x A \Delta x_{nt}\| \\ &= \|\Delta x_{nt}\|_{H_x}\end{aligned}$$

Square of Newton decrement is linear estimate of reduction if we do a Newton step:

$$-\lambda_t(x)^2 = \nabla f_t(x)^T \Delta x_{nt}$$

- ▶ $\lambda_t(x) = 0$ iff $x = x^*(t)$
- ▶ $\lambda_t(x)$ is measure of proximity of x to $x^*(t)$

Recall that Δx_{nt} fulfills $-H(x)\Delta x_{nt} = \nabla f_t(x)$.

Convergence of Newtons Method

Theorem 55

If $\lambda_t(x) < 1$ then

- ▶ $x_+ := x + \Delta x_{nt} \in P^\circ$ (new point feasible)
- ▶ $\lambda_t(x_+) \leq \lambda_t(x)^2$

This means we have **quadratic convergence**. Very fast.

Convergence of Newtons Method

feasibility:

- ▶ $\lambda_t(x) = \|\Delta x_{nt}\|_{H_x} < 1$; hence x_+ lies in the **Dikin ellipsoid** around x .

Convergence of Newtons Method

bound on $\lambda_t(x^+)$:

we use $D := D_x = \text{diag}(d_x)$ and $D_+ := D_{x^+} = \text{diag}(d_{x^+})$

$$\begin{aligned}\lambda_t(x^+)^2 &= \|D_+ A \Delta x_{nt}^+\|^2 \\ &\leq \|D_+ A \Delta x_{nt}^+\|^2 + \|D_+ A \Delta x_{nt}^+ + (I - D_+^{-1} D) D A \Delta x_{nt}\|^2 \\ &= \|(I - D_+^{-1} D) D A \Delta x_{nt}\|^2\end{aligned}$$

To see the last equality we use Pythagoras

$$\|a\|^2 + \|a + b\|^2 = \|b\|^2$$

if $a^T(a + b) = 0$.

Convergence of Newtons Method

$$\begin{aligned}
 DA\Delta x_{nt} &= DA(x^+ - x) \\
 &= D(b - Ax - (b - Ax^+)) \\
 &= D(D^{-1}\bar{1} - D_+^{-1}\bar{1}) \\
 &= (I - D_+^{-1}D)\bar{1}
 \end{aligned}$$

$$\begin{aligned}
 a^T(a + b) &= \Delta x_{nt}^{+T} A^T D_+ (D_+ A \Delta x_{nt}^+ + (I - D_+^{-1}D) DA \Delta x_{nt}) \\
 &= \Delta x_{nt}^{+T} (A^T D_+^2 A \Delta x_{nt}^+ - A^T D^2 A \Delta x_{nt} + A^T D_+ DA \Delta x_{nt}) \\
 &= \Delta x_{nt}^{+T} (H_+ \Delta x_{nt}^+ - H \Delta x_{nt} + A^T D_+ \bar{1} - A^T D \bar{1}) \\
 &= \Delta x_{nt}^{+T} (-\nabla f_t(x^+) + \nabla f_t(x) + \nabla \phi(x^+) - \nabla \phi(x)) \\
 &= 0
 \end{aligned}$$

If $\lambda_t(x)$ is large we do not have a guarantee.

Try to avoid this case!!!

Convergence of Newtons Method

bound on $\lambda_t(x^+)$:

we use $D := D_x = \text{diag}(d_x)$ and $D_+ := D_{x^+} = \text{diag}(d_{x^+})$

$$\begin{aligned}
 \lambda_t(x^+)^2 &= \|D_+ A \Delta x_{nt}^+\|^2 \\
 &\leq \|D_+ A \Delta x_{nt}^+\|^2 + \|D_+ A \Delta x_{nt}^+ + (I - D_+^{-1}D) DA \Delta x_{nt}\|^2 \\
 &= \|(I - D_+^{-1}D) DA \Delta x_{nt}\|^2 \\
 &= \|(I - D_+^{-1}D)^2 \bar{1}\|^2 \\
 &\leq \|(I - D_+^{-1}D) \bar{1}\|^4 \\
 &= \|DA \Delta x_{nt}\|^4 \\
 &= \lambda_t(x)^4
 \end{aligned}$$

The second inequality follows from $\sum_i y_i^4 \leq (\sum_i y_i^2)^2$

Path-following Methods

Try to slowly travel along the central path.

Algorithm 1 PathFollowing

- 1: start at analytic center
- 2: **while** solution not good enough **do**
- 3: make step to improve objective function
- 4: recenter to return to central path

Short Step Barrier Method

simplifying assumptions:

- ▶ a first central point $x^*(t_0)$ is given
- ▶ $x^*(t)$ is computed exactly in each iteration

ϵ is approximation we are aiming for

start at $t = t_0$, repeat until $m/t \leq \epsilon$

- ▶ compute $x^*(\mu t)$ using Newton starting from $x^*(t)$
- ▶ $t := \mu t$

where $\mu = 1 + 1/(2\sqrt{m})$

Short Step Barrier Method

gradient of f_{t+} at $(x = x^*(t))$

$$\begin{aligned}\nabla f_{t+}(x) &= \nabla f_t(x) + (\mu - 1)tc \\ &= -(\mu - 1)A^T D_x \bar{1}\end{aligned}$$

This holds because $0 = \nabla f_t(x) = tc + A^T D_x \bar{1}$.

The Newton decrement is

$$\begin{aligned}\lambda_{t+}(x)^2 &= \nabla f_{t+}(x)^T H^{-1} \nabla f_{t+}(x) \\ &= (\mu - 1)^2 \bar{1}^T B (B^T B)^{-1} B^T \bar{1} \quad B = D_x^T A \\ &\leq (\mu - 1)^2 m \\ &= 1/4\end{aligned}$$

This means we are in the range of quadratic convergence!!!

Number of Iterations

the number of Newton iterations per outer iteration is very small; in practise only 1 or 2

Number of outer iterations:

We need $t_k = \mu^k t_0 \geq m/\epsilon$. This holds when

$$k \geq \frac{\log(m/(\epsilon t_0))}{\log(\mu)}$$

We get a bound of

$$\mathcal{O}\left(\sqrt{m} \log \frac{m}{\epsilon t_0}\right)$$

We show how to get a starting point with $t_0 = 1/2^L$. Together with $\epsilon \approx 2^{-L}$ we get $\mathcal{O}(L\sqrt{m})$ iterations.

Explanation for previous slide

$P = B(B^T B)^{-1} B^T$ is a symmetric real-valued matrix; it has n linearly independent Eigenvectors. Since it is a **projection matrix** ($P^2 = P$) it can only have Eigenvalues 0 and 1 (because the Eigenvalues of P^2 are λ_i^2 , where λ_i is Eigenvalue of P). The expression

$$\max_v \frac{v^T P v}{v^T v}$$

gives the largest Eigenvalue for P . Hence, $\bar{1}^T P \bar{1} \leq \bar{1}^T \bar{1} = m$

Damped Newton Method

We assume that the polytope (not just the LP) is bounded. Then $Av \leq 0$ is not possible.

For $x \in P^\circ$ and direction $v \neq 0$ define

$$\sigma_x(v) := \max_i \frac{a_i^T v}{s_i(x)}$$

$a_i^T v$ is the change on the left hand side of the i -th constraint when moving in direction of v . If $\sigma_x(v) > 1$ then for one coordinate this change is larger than the slack in the constraint at position x .

By downscaling v we can ensure to stay in the polytope.

Observation:

$$x + \alpha v \in P \quad \text{for } \alpha \in \{0, 1/\sigma_x(v)\}$$

Damped Newton Method

Suppose that we move from x to $x + \alpha v$. The linear estimate says that $f_t(x)$ should change by $\nabla f_t(x)^T \alpha v$.

The following argument shows that f_t is well behaved. For small α the reduction of $f_t(x)$ is close to linear estimate.

$$f_t(x + \alpha v) - f_t(x) = tc^T \alpha v + \phi(x + \alpha v) - \phi(x)$$

$$\begin{aligned} \phi(x + \alpha v) - \phi(x) &= -\sum_i \log(s_i(x + \alpha v)) + \sum_i \log(s_i(x)) \\ &= -\sum_i \log(s_i(x + \alpha v)/s_i(x)) \\ &= -\sum_i \log(1 - a_i^T \alpha v / s_i(x)) \end{aligned}$$

$$s_i(x + \alpha v) = b_i - a_i^T x - a_i^T \alpha v = s_i(x) - a_i^T \alpha v$$

Damped Newton Method

$$\begin{aligned} \nabla f_t(x)^T \alpha v &= (tc^T + \sum_i a_i^T / s_i(x)) \alpha v \\ &= tc^T \alpha v + \sum_i \alpha w_i \end{aligned}$$

Define $w_i = a_i^T v / s_i(x)$ and $\sigma = \max_i w_i$. Then

Note that $\|w\| = \|v\|_{H_x}$.

$$\begin{aligned} f_t(x + \alpha v) - f_t(x) - \nabla f_t(x)^T \alpha v &= -\sum_i (\alpha w_i + \log(1 - \alpha w_i)) \\ &\leq -\sum_{w_i > 0} (\alpha w_i + \log(1 - \alpha w_i)) + \sum_{w_i \leq 0} \frac{\alpha^2 w_i^2}{2} \\ &\leq -\sum_{w_i > 0} \frac{w_i^2}{\sigma^2} (\alpha \sigma + \log(1 - \alpha \sigma)) + \frac{(\alpha \sigma)^2}{2} \sum_{w_i \leq 0} \frac{w_i^2}{\sigma^2} \end{aligned}$$

For $|x| < 1, x \leq 0$:

$$x + \log(1 - x) = -\frac{x^2}{2} - \frac{x^3}{3} - \frac{x^4}{4} - \dots \geq -\frac{x^2}{2} = -\frac{y^2}{2} \frac{x^2}{y^2}$$

For $|x| < 1, 0 < x \leq y$:

$$\begin{aligned} x + \log(1 - x) &= -\frac{x^2}{2} - \frac{x^3}{3} - \frac{x^4}{4} - \dots = \frac{x^2}{y^2} \left(-\frac{y^2}{2} - \frac{y^2 x}{3} - \frac{y^2 x^2}{4} - \dots \right) \\ &\geq \frac{x^2}{y^2} \left(-\frac{y^2}{2} - \frac{y^3}{3} - \frac{y^4}{4} - \dots \right) = \frac{x^2}{y^2} (y + \log(1 - y)) \end{aligned}$$

Damped Newton Method

$$\text{For } x \geq 0: \frac{x^2}{2} \leq \frac{x^2}{2} + \frac{x^3}{3} + \frac{x^4}{4} + \dots = -(x + \log(1 - x))$$

$$\begin{aligned} &\leq -\sum_i \frac{w_i^2}{\sigma^2} (\alpha \sigma + \log(1 - \alpha \sigma)) \\ &= -\frac{1}{\sigma^2} \|v\|_{H_x}^2 (\alpha \sigma + \log(1 - \alpha \sigma)) \end{aligned}$$

Damped Newton Iteration:

In a damped Newton step we choose

$$x_+ = x + \frac{1}{1 + \sigma_x(\Delta x_{nt})} \Delta x_{nt}$$

This means that in the above expressions we choose $\alpha = \frac{1}{1 + \sigma}$ and $v = \Delta x_{nt}$. Note that it wouldn't make sense to choose α larger than 1 as this would mean that our real target $(x + \Delta x_{nt})$ is inside the polytope but we overshoot and go further than this target.

Damped Newton Method

Theorem:

In a damped Newton step the cost decreases by at least

$$\lambda_t(x) - \log(1 + \lambda_t(x))$$

Proof: The decrease in cost is

$$-\alpha \nabla f_t(x)^T v + \frac{1}{\sigma^2} \|v\|_{H_x}^2 (\alpha \sigma + \log(1 - \alpha \sigma))$$

Choosing $\alpha = \frac{1}{1 + \sigma}$ and $v = \Delta x_{nt}$ gives

$$\begin{aligned} &\frac{1}{1 + \sigma} \lambda_t(x)^2 + \frac{\lambda_t(x)^2}{\sigma^2} \left(\frac{\sigma}{1 + \sigma} + \log\left(1 - \frac{\sigma}{1 + \sigma}\right) \right) \\ &= \frac{\lambda_t(x)^2}{\sigma^2} (\sigma - \log(1 + \sigma)) \end{aligned}$$

With $v = \Delta x_{nt}$ we have $\|w\|_2 = \|v\|_{H_x} = \lambda_t(x)$; further recall that $\sigma = \|w\|_\infty$; hence $\sigma \leq \lambda_t(x)$.

Damped Newton Method

The first inequality follows since the function $\frac{1}{x^2}(x - \log(1+x))$ is monotonically decreasing.

$$\begin{aligned} &\geq \lambda_t(x) - \log(1 + \lambda_t(x)) \\ &\geq 0.09 \end{aligned}$$

for $\lambda_t(x) \geq 0.5$

Centering Algorithm:

Input: precision δ ; starting point x

1. compute Δx_{nt} and $\lambda_t(x)$
2. if $\lambda_t(x) \leq \delta$ return x
3. set $x := x + \alpha \Delta x_{nt}$ with

$$\alpha = \begin{cases} \frac{1}{1 + \sigma_x(\Delta x_{nt})} & \lambda_t \geq 1/2 \\ 1 & \text{otw.} \end{cases}$$

Centering

Lemma 56

The centering algorithm starting at x_0 reaches a point with $\lambda_t(x) \leq \delta$ after

$$\frac{f_t(x_0) - \min_y f_t(y)}{0.09} + \mathcal{O}(\log \log(1/\delta))$$

iterations.

This can be very, very slow...

How to get close to analytic center?

Let $P = \{Ax \leq b\}$ be our (feasible) polyhedron, and x_0 a feasible point.

We change $b \rightarrow b + \frac{1}{\lambda} \cdot \bar{1}$, where $L = \langle A \rangle + \langle b \rangle + \langle c \rangle$ (encoding length) and $\lambda = 2^{2L}$. Recall that a basis is feasible in the old LP iff it is feasible in the new LP.

Lemma [without proof]

The inverse of a matrix M can be represented with rational numbers that have denominators $z_{ij} = \det(M)$.

For two basis solutions $x_B, x_{\bar{B}}$, the cost-difference $c^T x_B - c^T x_{\bar{B}}$ can be represented by a rational number that has denominator $z = \det(A_B) \cdot \det(A_{\bar{B}})$.

This means that in the perturbed LP it is sufficient to decrease the duality gap to $1/2^{4L}$ (i.e., $t \approx 2^{4L}$). This means the previous analysis essentially also works for the perturbed LP.

For a point x from the polytope (not necessarily BFS) the objective value $\bar{c}^T x$ is at most $n2^M 2^L$, where $M \leq L$ is the encoding length of the largest entry in \bar{c} .

How to get close to analytic center?

Start at x_0 .

Choose $\hat{c} := -\nabla\phi(x)$.

$x_0 = x^*(1)$ is point on central path for \hat{c} and $t = 1$.

You can travel the central path in both directions. Go towards 0 until $t \approx 1/2^{\Omega(L)}$. This requires $O(\sqrt{mL})$ outer iterations.

Let $x_{\hat{c}}$ denote this point.

Let x_c denote the point that minimizes

$$t \cdot c^T x + \phi(x)$$

(i.e., same value for t but different c , hence, different central path).

Note that an entry in \hat{c} fulfills $|\hat{c}_i| \leq 2^{2L}$. This holds since the slack in every constraint at x_0 is at least $\lambda = 1/2^{2L}$, and the gradient is the vector of inverse slacks.

How to get close to analytic center?

Clearly,

$$t \cdot \hat{c}^T x_{\hat{c}} + \phi(x_{\hat{c}}) \leq t \cdot \hat{c}^T x_c + \phi(x_c)$$

The difference between $f_t(x_{\hat{c}})$ and $f_t(x_c)$ is

$$\begin{aligned} t c^T x_{\hat{c}} + \phi(x_{\hat{c}}) - t c^T x_c - \phi(x_c) \\ \leq t(c^T x_{\hat{c}} + \hat{c}^T x_c - \hat{c}^T x_{\hat{c}} - c^T x_c) \\ \leq 4tn2^{3L} \end{aligned}$$

For $t = 1/2^{\Omega(L)}$ the last term becomes constant. Hence, using damped Newton we can move from $x_{\hat{c}}$ to x_c quickly.

In total for this analysis we require $O(\sqrt{mL})$ outer iterations for the whole algorithm.

One iteration can be implemented in $\tilde{O}(m^3)$ time.

Part III

Approximation Algorithms

There are many practically important optimization problems that are NP-hard.

What can we do?

- ▶ Heuristics.
- ▶ Exploit special structure of instances occurring in practise.
- ▶ Consider algorithms that do not compute the optimal solution but provide solutions that are close to optimum.

Definition 57

An α -approximation for an optimization problem is a polynomial-time algorithm that for all instances of the problem produces a solution whose value is within a factor of α of the value of an optimal solution.

Why approximation algorithms?

- ▶ We need algorithms for hard problems.
- ▶ It gives a rigorous mathematical base for studying heuristics.
- ▶ It provides a metric to compare the difficulty of various optimization problems.
- ▶ Proving theorems may give a deeper theoretical understanding which in turn leads to new algorithmic approaches.

Why not?

- ▶ Sometimes the results are very pessimistic due to the fact that an algorithm has to provide a close-to-optimum solution on every instance.

Definition 58

An optimization problem $P = (\mathcal{I}, \text{sol}, m, \text{goal})$ is in NPO if

- ▶ $x \in \mathcal{I}$ can be **decided** in polynomial time
- ▶ $y \in \text{sol}(\mathcal{I})$ can be **verified** in polynomial time
- ▶ m can be computed in polynomial time
- ▶ $\text{goal} \in \{\min, \max\}$

In other words: the decision problem **is there a solution y with $m(x, y)$ at most/at least z** is in NP.

- ▶ x is problem instance
- ▶ y is candidate solution
- ▶ $m^*(x)$ cost/profit of an optimal solution

Definition 59 (Performance Ratio)

$$R(x, y) := \max \left\{ \frac{m(x, y)}{m^*(x)}, \frac{m^*(x)}{m(x, y)} \right\}$$

Definition 60 (r -approximation)

An algorithm A is an r -approximation algorithm iff

$$\forall x \in \mathcal{I} : R(x, A(x)) \leq r ,$$

and A runs in polynomial time.

Definition 61 (PTAS)

A PTAS for a problem P from NPO is an algorithm that takes as input $x \in \mathcal{I}$ and $\epsilon > 0$ and produces a solution y for x with

$$R(x, y) \leq 1 + \epsilon .$$

The running time is polynomial in $|x|$.

approximation with arbitrary good factor... fast?

Problems that have a PTAS

Scheduling. Given m jobs with known processing times; schedule the jobs on n machines such that the MAKESPAN is minimized.

Definition 62 (FPTAS)

An FPTAS for a problem P from NPO is an algorithm that takes as input $x \in \mathcal{I}$ and $\epsilon > 0$ and produces a solution y for x with

$$R(x, y) \leq 1 + \epsilon .$$

The running time is polynomial in $|x|$ and $1/\epsilon$.

approximation with arbitrary good factor... fast!

Problems that have an FPTAS

KNAPSACK. Given a set of items with profits and weights choose a subset of total weight at most W s.t. the profit is maximized.

Definition 63 (APX – approximable)

A problem P from NPO is in APX if there exist a constant $r \geq 1$ and an r -approximation algorithm for P .

constant factor approximation...

Problems that are in APX

MAXCUT. Given a graph $G = (V, E)$; partition V into two disjoint pieces A and B s.t. the number of edges between both pieces is maximized.

MAX-3SAT. Given a 3CNF-formula. Find an assignment to the variables that satisfies the maximum number of clauses.

Problems with polylogarithmic approximation guarantees

- ▶ Set Cover
- ▶ Minimum Multicut
- ▶ Sparsest Cut
- ▶ Minimum Bisection

There is an r -approximation with $r \leq \mathcal{O}(\log^c(|x|))$ for some constant c .

Note that only for some of the above problem a matching lower bound is known.

There are really difficult problems!

Theorem 64

For any constant $\epsilon > 0$ there does not exist an $\Omega(n^{1-\epsilon})$ -approximation algorithm for the maximum clique problem on a given graph G with n nodes unless $P = NP$.

Note that an n -approximation is trivial.

There are weird problems!

Asymmetric k -Center admits an $\mathcal{O}(\log^* n)$ -approximation.

There is no $o(\log^* n)$ -approximation to Asymmetric k -Center unless $NP \subseteq DTIME(n^{\log \log \log n})$.

Class APX not important in practise.

Instead of saying **problem P is in APX** one says **problem P admits a 4-approximation**.

One only says that a problem is **APX-hard**.

A crucial ingredient for the design and analysis of approximation algorithms is a technique to obtain an upper bound (for maximization problems) or a lower bound (for minimization problems).

Therefore **Linear Programs** or **Integer Linear Programs** play a vital role in the design of many approximation algorithms.

Definition 65

An **Integer Linear Program** or **Integer Program** is a Linear Program in which all variables are required to be integral.

Definition 66

A **Mixed Integer Program** is a Linear Program in which a subset of the variables are required to be integral.

Many important combinatorial optimization problems can be formulated in the form of an Integer Program.

Note that solving Integer Programs in general is NP-complete!

Set Cover

Given a ground set U , a collection of subsets $S_1, \dots, S_k \subseteq U$, where the i -th subset S_i has weight/cost w_i . Find a collection $I \subseteq \{1, \dots, k\}$ such that

$$\forall u \in U \exists i \in I: u \in S_i \text{ (every element is covered)}$$

and

$$\sum_{i \in I} w_i \text{ is minimized.}$$

Set Cover

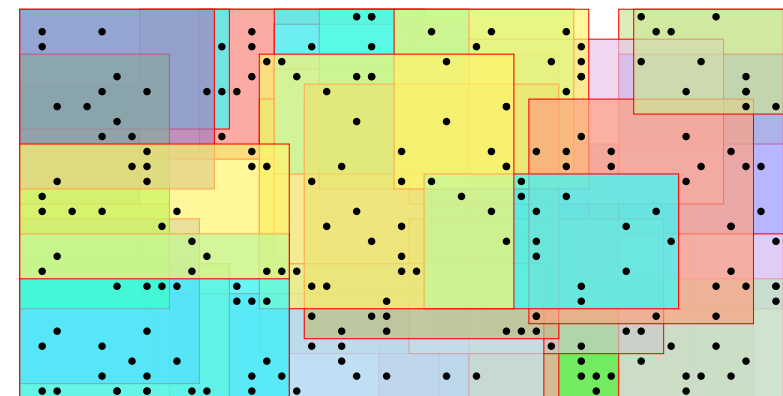

IP-Formulation of Set Cover

$$\begin{array}{ll} \min & \sum_i w_i x_i \\ \text{s.t.} & \forall u \in U \quad \sum_{i:u \in S_i} x_i \geq 1 \\ & \forall i \in \{1, \dots, k\} \quad x_i \geq 0 \\ & \forall i \in \{1, \dots, k\} \quad x_i \text{ integral} \end{array}$$

Vertex Cover

Given a graph $G = (V, E)$ and a weight w_v for every node. Find a vertex subset $S \subseteq V$ of minimum weight such that every edge is incident to at least one vertex in S .

IP-Formulation of Vertex Cover

$$\begin{array}{ll} \min & \sum_{v \in V} w_v x_v \\ \text{s.t.} & \forall e = (i, j) \in E \quad x_i + x_j \geq 1 \\ & \forall v \in V \quad x_v \in \{0, 1\} \end{array}$$

Maximum Weighted Matching

Given a graph $G = (V, E)$, and a weight w_e for every edge $e \in E$. Find a subset of edges of maximum weight such that no vertex is incident to more than one edge.

$$\begin{array}{ll} \max & \sum_{e \in E} w_e x_e \\ \text{s.t.} & \forall v \in V \quad \sum_{e: v \in e} x_e \leq 1 \\ & \forall e \in E \quad x_e \in \{0, 1\} \end{array}$$

Maximum Independent Set

Given a graph $G = (V, E)$, and a weight w_v for every node $v \in V$. Find a subset $S \subseteq V$ of nodes of maximum weight such that no two vertices in S are adjacent.

$$\begin{array}{ll} \max & \sum_{v \in V} w_v x_v \\ \text{s.t.} & \forall e = (i, j) \in E \quad x_i + x_j \leq 1 \\ & \forall v \in V \quad x_v \in \{0, 1\} \end{array}$$

Knapsack

Given a set of items $\{1, \dots, n\}$, where the i -th item has weight w_i and profit p_i , and given a threshold K . Find a subset $I \subseteq \{1, \dots, n\}$ of items of total weight at most K such that the profit is maximized.

$$\begin{array}{ll} \max & \sum_{i=1}^n p_i x_i \\ \text{s.t.} & \sum_{i=1}^n w_i x_i \leq K \\ & \forall i \in \{1, \dots, n\} \quad x_i \in \{0, 1\} \end{array}$$

Relaxations

Definition 67

A linear program LP is a **relaxation** of an integer program IP if any feasible solution for IP is also feasible for LP and if the objective values of these solutions are identical in both programs.

We obtain a relaxation for all examples by writing $x_i \in [0, 1]$ instead of $x_i \in \{0, 1\}$.

By solving a relaxation we obtain an upper bound for a maximization problem and a lower bound for a minimization problem.

Relations

Maximization Problems:

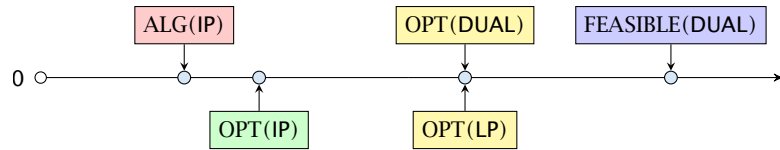

Minimization Problems:

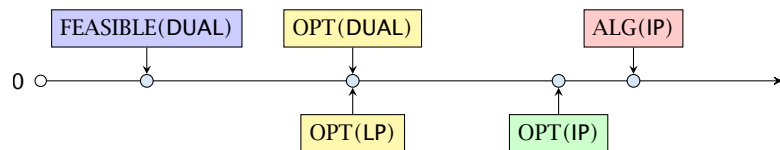

Technique 1: Round the LP solution.

We first solve the LP-relaxation and then we round the fractional values so that we obtain an integral solution.

Set Cover relaxation:

$$\begin{array}{ll} \min & \sum_{i=1}^k w_i x_i \\ \text{s.t.} & \forall u \in U \quad \sum_{i:u \in S_i} x_i \geq 1 \\ & \forall i \in \{1, \dots, k\} \quad x_i \in [0, 1] \end{array}$$

Let f_u be the number of sets that the element u is contained in (the frequency of u). Let $f = \max_u \{f_u\}$ be the maximum frequency.

Technique 1: Round the LP solution.

Rounding Algorithm:

Set all x_i -values with $x_i \geq \frac{1}{f}$ to 1. Set all other x_i -values to 0.

Technique 1: Round the LP solution.

Lemma 68

The rounding algorithm gives an f -approximation.

Proof: Every $u \in U$ is covered.

- ▶ We know that $\sum_{i:u \in S_i} x_i \geq 1$.
- ▶ The sum contains at most $f_u \leq f$ elements.
- ▶ Therefore one of the sets that contain u must have $x_i \geq 1/f$.
- ▶ This set will be selected. Hence, u is covered.

Technique 1: Round the LP solution.

The cost of the rounded solution is at most $f \cdot \text{OPT}$.

$$\begin{aligned}\sum_{i \in I} w_i &\leq \sum_{i=1}^k w_i (f \cdot x_i) \\ &= f \cdot \text{cost}(x) \\ &\leq f \cdot \text{OPT} .\end{aligned}$$

Technique 2: Rounding the Dual Solution.

Relaxation for Set Cover

Primal:

$$\begin{aligned}\min & \sum_{i \in I} w_i x_i \\ \text{s.t. } \forall u & \sum_{i: u \in S_i} x_i \geq 1 \\ & x_i \geq 0\end{aligned}$$

Dual:

$$\begin{aligned}\max & \sum_{u \in U} y_u \\ \text{s.t. } \forall i & \sum_{u: u \in S_i} y_u \leq w_i \\ & y_u \geq 0\end{aligned}$$

Technique 2: Rounding the Dual Solution.

Rounding Algorithm:

Let I denote the index set of sets for which the dual constraint is tight. This means for all $i \in I$

$$\sum_{u: u \in S_i} y_u = w_i$$

Technique 2: Rounding the Dual Solution.

Lemma 69

The resulting index set is an f -approximation.

Proof:

Every $u \in U$ is covered.

- ▶ Suppose there is a u that is not covered.
- ▶ This means $\sum_{u: u \in S_i} y_u < w_i$ for all sets S_i that contain u .
- ▶ But then y_u could be increased in the dual solution without violating any constraint. This is a contradiction to the fact that the dual solution is optimal.

Technique 2: Rounding the Dual Solution.

Proof:

$$\begin{aligned}\sum_{i \in I} w_i &= \sum_{i \in I} \sum_{u \in S_i} \gamma_u \\ &= \sum_u |\{i \in I : u \in S_i\}| \cdot \gamma_u \\ &\leq \sum_u f_u \gamma_u \\ &\leq f \sum_u \gamma_u \\ &\leq f \cdot \text{cost}(x^*) \\ &\leq f \cdot \text{OPT}\end{aligned}$$

Let I denote the solution obtained by the first rounding algorithm and I' be the solution returned by the second algorithm. Then

$$I \subseteq I'.$$

This means I' is never better than I .

- ▶ Suppose that we take S_i in the first algorithm. I.e., $i \in I$.
- ▶ This means $x_i \geq \frac{1}{f}$.
- ▶ Because of **Complementary Slackness Conditions** the corresponding constraint in the dual must be tight.
- ▶ Hence, the second algorithm will also choose S_i .

Technique 3: The Primal Dual Method

The previous two rounding algorithms have the disadvantage that it is necessary to solve the LP. The following method also gives an f -approximation without solving the LP.

For estimating the cost of the solution we only required two properties.

1. The solution is dual feasible and, hence,

$$\sum_u \gamma_u \leq \text{cost}(x^*) \leq \text{OPT}$$

where x^* is an optimum solution to the primal LP.

2. The set I contains only sets for which the dual inequality is tight.

Of course, we also need that I is a cover.

Technique 3: The Primal Dual Method

Algorithm 1 PrimalDual

```
1:  $\gamma \leftarrow 0$ 
2:  $I \leftarrow \emptyset$ 
3: while exists  $u \notin \bigcup_{i \in I} S_i$  do
4:   increase dual variable  $\gamma_u$  until constraint for some
   new set  $S_\ell$  becomes tight
5:    $I \leftarrow I \cup \{\ell\}$ 
```

Technique 4: The Greedy Algorithm

Algorithm 1 Greedy

```
1:  $I \leftarrow \emptyset$ 
2:  $\hat{S}_j \leftarrow S_j$  for all  $j$ 
3: while  $I$  not a set cover do
4:    $\ell \leftarrow \arg \min_{j: \hat{S}_j \neq \emptyset} \frac{w_j}{|\hat{S}_j|}$ 
5:    $I \leftarrow I \cup \{\ell\}$ 
6:    $\hat{S}_j \leftarrow \hat{S}_j - S_\ell$  for all  $j$ 
```

In every round the Greedy algorithm takes the set that covers remaining elements in the most **cost-effective** way.

We choose a set such that the ratio between cost and still uncovered elements in the set is minimized.

Technique 4: The Greedy Algorithm

Lemma 70

Given positive numbers a_1, \dots, a_k and b_1, \dots, b_k , and $S \subseteq \{1, \dots, k\}$ then

$$\min_i \frac{a_i}{b_i} \leq \frac{\sum_{i \in S} a_i}{\sum_{i \in S} b_i} \leq \max_i \frac{a_i}{b_i}$$

Technique 4: The Greedy Algorithm

Let n_ℓ denote the number of elements that remain at the beginning of iteration ℓ . $n_1 = n = |U|$ and $n_{s+1} = 0$ if we need s iterations.

In the ℓ -th iteration

$$\min_j \frac{w_j}{|\hat{S}_j|} \leq \frac{\sum_{j \in \text{OPT}} w_j}{\sum_{j \in \text{OPT}} |\hat{S}_j|} = \frac{\text{OPT}}{\sum_{j \in \text{OPT}} |\hat{S}_j|} \leq \frac{\text{OPT}}{n_\ell}$$

since an optimal algorithm can cover the remaining n_ℓ elements with cost **OPT**.

Let \hat{S}_j be a subset that minimizes this ratio. Hence,
 $w_j / |\hat{S}_j| \leq \frac{\text{OPT}}{n_\ell}$.

Technique 4: The Greedy Algorithm

Adding this set to our solution means $n_{\ell+1} = n_\ell - |\hat{S}_j|$.

$$w_j \leq \frac{|\hat{S}_j| \text{OPT}}{n_\ell} = \frac{n_\ell - n_{\ell+1}}{n_\ell} \cdot \text{OPT}$$

Technique 4: The Greedy Algorithm

$$\begin{aligned}
 \sum_{j \in I} w_j &\leq \sum_{\ell=1}^s \frac{n_\ell - n_{\ell+1}}{n_\ell} \cdot \text{OPT} \\
 &\leq \text{OPT} \sum_{\ell=1}^s \left(\frac{1}{n_\ell} + \frac{1}{n_\ell - 1} + \dots + \frac{1}{n_{\ell+1} + 1} \right) \\
 &= \text{OPT} \sum_{i=1}^n \frac{1}{i} \\
 &= H_n \cdot \text{OPT} \leq \text{OPT}(\ln n + 1) .
 \end{aligned}$$

Technique 4: The Greedy Algorithm

A tight example:

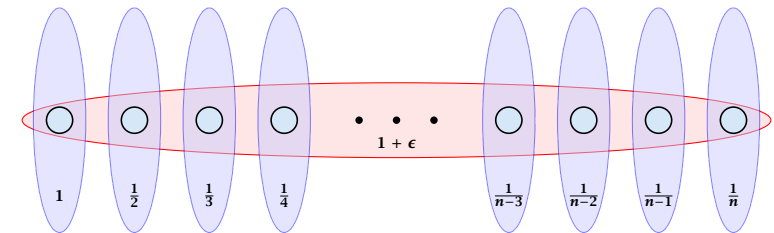

Technique 5: Randomized Rounding

One round of randomized rounding:

Pick set S_j uniformly at random with probability $1 - x_j$ (for all j).

Version A: Repeat rounds until you nearly have a cover. Cover remaining elements by some simple heuristic.

Version B: Repeat for s rounds. If you have a cover STOP. Otherwise, repeat the whole algorithm.

Probability that $u \in U$ is not covered (in one round):

$\Pr[u \text{ not covered in one round}]$

$$\begin{aligned}
 &= \prod_{j: u \in S_j} (1 - x_j) \leq \prod_{j: u \in S_j} e^{-x_j} \\
 &= e^{-\sum_{j: u \in S_j} x_j} \leq e^{-1} .
 \end{aligned}$$

Probability that $u \in U$ is not covered (after ℓ rounds):

$$\Pr[u \text{ not covered after } \ell \text{ round}] \leq \frac{1}{e^\ell} .$$

$$\begin{aligned} & \Pr[\exists u \in U \text{ not covered after } \ell \text{ round}] \\ &= \Pr[u_1 \text{ not covered} \vee u_2 \text{ not covered} \vee \dots \vee u_n \text{ not covered}] \\ &\leq \sum_i \Pr[u_i \text{ not covered after } \ell \text{ rounds}] \leq ne^{-\ell}. \end{aligned}$$

Lemma 71

With high probability $\mathcal{O}(\log n)$ rounds suffice.

With high probability:

For any constant α the number of rounds is at most $\mathcal{O}(\log n)$ with probability at least $1 - n^{-\alpha}$.

Proof: We have

$$\Pr[\#rounds \geq (\alpha + 1) \ln n] \leq ne^{-(\alpha+1) \ln n} = n^{-\alpha}.$$

Expected Cost

- ▶ Version A.
Repeat for $s = (\alpha + 1) \ln n$ rounds. If you don't have a cover simply take for each element u the cheapest set that contains u .

$$E[\text{cost}] \leq (\alpha + 1) \ln n \cdot \text{cost}(LP) + (n \cdot \text{OPT}) n^{-\alpha} = \mathcal{O}(\ln n) \cdot \text{OPT}$$

Expected Cost

- ▶ Version B.
Repeat for $s = (\alpha + 1) \ln n$ rounds. If you don't have a cover simply repeat the whole process.

$$\begin{aligned} E[\text{cost}] &= \Pr[\text{success}] \cdot E[\text{cost} \mid \text{success}] \\ &\quad + \Pr[\text{no success}] \cdot E[\text{cost} \mid \text{no success}] \end{aligned}$$

This means

$$\begin{aligned} & E[\text{cost} \mid \text{success}] \\ &= \frac{1}{\Pr[\text{succ.}]} \left(E[\text{cost}] - \Pr[\text{no success}] \cdot E[\text{cost} \mid \text{no success}] \right) \\ &\leq \frac{1}{\Pr[\text{succ.}]} E[\text{cost}] \leq \frac{1}{1 - n^{-\alpha}} (\alpha + 1) \ln n \cdot \text{cost}(LP) \\ &\leq 2(\alpha + 1) \ln n \cdot \text{OPT} \end{aligned}$$

for $n \geq 2$ and $\alpha \geq 1$.

Randomized rounding gives an $\mathcal{O}(\log n)$ approximation. The running time is polynomial with high probability.

Theorem 72 (without proof)

There is no approximation algorithm for set cover with approximation guarantee better than $\frac{1}{2} \log n$ unless NP has quasi-polynomial time algorithms (algorithms with running time $2^{\text{poly}(\log n)}$).

Integrality Gap

The **integrality gap** of the SetCover LP is $\Omega(\log n)$.

- ▶ $n = 2^k - 1$
- ▶ Elements are all vectors \vec{x} over $GF[2]$ of length k (excluding zero vector).
- ▶ Every vector \vec{y} defines a set as follows

$$S_{\vec{y}} := \{\vec{x} \mid \vec{x}^T \vec{y} = 1\}$$

- ▶ each set contains 2^{k-1} vectors; each vector is contained in 2^{k-1} sets
- ▶ $x_i = \frac{1}{2^{k-1}} = \frac{2}{n+1}$ is fractional solution.

Integrality Gap

Every collection of $p < k$ sets does not cover all elements.

Hence, we get a gap of $\Omega(\log n)$.

Techniques:

- ▶ Deterministic Rounding
- ▶ Rounding of the Dual
- ▶ Primal Dual
- ▶ Greedy
- ▶ Randomized Rounding
- ▶ Local Search
- ▶ Rounding Data + Dynamic Programming

Scheduling Jobs on Identical Parallel Machines

Given n jobs, where job $j \in \{1, \dots, n\}$ has processing time p_j .
Schedule the jobs on m identical parallel machines such that the **Makespan** (finishing time of the last job) is minimized.

$$\begin{array}{ll} \min & L \\ \text{s.t.} & \forall \text{ machines } i \quad \sum_j p_j \cdot x_{j,i} \leq L \\ & \forall \text{ jobs } j \quad \sum_i x_{j,i} \geq 1 \\ & \forall i, j \quad x_{j,i} \in \{0, 1\} \end{array}$$

Here the variable $x_{j,i}$ is the decision variable that describes whether job j is assigned to machine i .

Lower Bounds on the Solution

Let for a given schedule C_j denote the finishing time of machine j , and let C_{\max} be the makespan.

Let C_{\max}^* denote the makespan of an optimal solution.

Clearly

$$C_{\max}^* \geq \max_j p_j$$

as the longest job needs to be scheduled somewhere.

Lower Bounds on the Solution

The average work performed by a machine is $\frac{1}{m} \sum_j p_j$.
Therefore,

$$C_{\max}^* \geq \frac{1}{m} \sum_j p_j$$

Local Search

A local search algorithm successively makes certain small (cost/profit improving) changes to a solution until it does not find such changes anymore.

It is conceptionally very different from a Greedy algorithm as a feasible solution is always maintained.

Sometimes the running time is difficult to prove.

Local Search for Scheduling

Local Search Strategy: Take the job that finishes last in the produced schedule. Move it to another machine. If there is such a move that reduces the makespan, perform the switch.

REPEAT

Local Search Analysis

Let ℓ be the job that finishes last in the produced schedule.

Let S_ℓ be its start time, and let C_ℓ be its completion time.

Note that every machine is busy before time S_ℓ , because otherwise we could move the job ℓ and hence our schedule would not be locally optimal.

We can split the total processing time into two intervals one from 0 to S_ℓ the other from S_ℓ to C_ℓ .

The interval $[S_\ell, C_\ell]$ is of length $p_\ell \leq C_{\max}^*$.

During the first interval $[0, S_\ell]$ all processors are busy, and, hence, the total work performed in this interval is

$$m \cdot S_\ell \leq \sum_{j \neq \ell} p_j.$$

Hence, the length of the schedule is at most

$$p_\ell + \frac{1}{m} \sum_{j \neq \ell} p_j = \left(1 - \frac{1}{m}\right)p_\ell + \frac{1}{m} \sum_j p_j \leq \left(2 - \frac{1}{m}\right)C_{\max}^*$$

A Tight Example

$$p_\ell \approx S_\ell + \frac{S_\ell}{m-1}$$

$$\frac{\text{ALG}}{\text{OPT}} = \frac{S_\ell + p_\ell}{p_\ell} \approx \frac{2 + \frac{1}{m-1}}{1 + \frac{1}{m-1}} = 2 - \frac{1}{m}$$

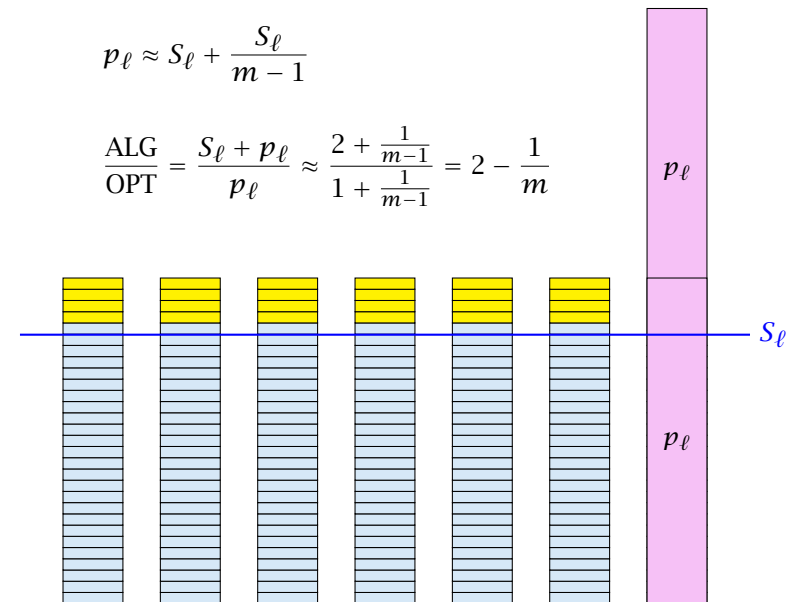

A Greedy Strategy

List Scheduling:

Order all processes in a list. When a machine runs empty assign the next yet unprocessed job to it.

Alternatively:

Consider processes in some order. Assign the i -th process to the least loaded machine.

It is easy to see that the result of these greedy strategies fulfill the local optimality condition of our local search algorithm. Hence, these also give 2-approximations.

A Greedy Strategy

Lemma 73

If we order the list according to non-increasing processing times the approximation guarantee of the list scheduling strategy improves to $4/3$.

Proof:

- ▶ Let $p_1 \geq \dots \geq p_n$ denote the processing times of a set of jobs that form a counter-example.
- ▶ Wlog. the last job to finish is n (otw. deleting this job gives another counter-example with fewer jobs).
- ▶ If $p_n \leq C_{\max}^*/3$ the previous analysis gives us a schedule length of at most

$$C_{\max}^* + p_n \leq \frac{4}{3} C_{\max}^* .$$

Hence, $p_n > C_{\max}^*/3$.

- ▶ This means that all jobs must have a processing time $> C_{\max}^*/3$.
- ▶ But then any machine in the optimum schedule can handle at most two jobs.
- ▶ For such instances Longest-Processing-Time-First is optimal.

When in an optimal solution a machine can have at most 2 jobs the optimal solution looks as follows.

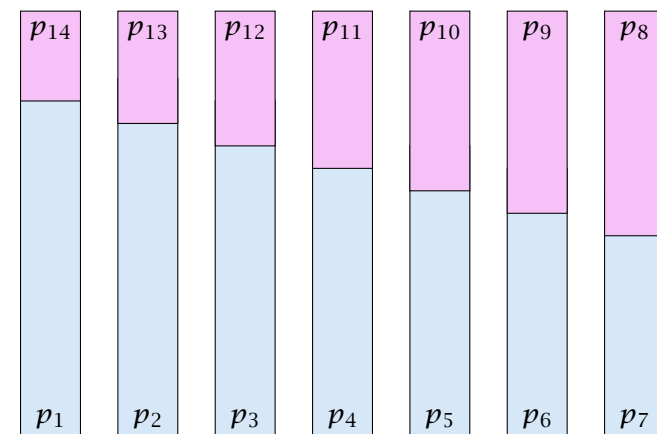

- ▶ We can assume that one machine schedules p_1 and p_n (the largest and smallest job).
- ▶ If not assume wlog. that p_1 is scheduled on machine A and p_n on machine B .
- ▶ Let p_A and p_B be the other job scheduled on A and B , respectively.
- ▶ $p_1 + p_n \leq p_1 + p_A$ and $p_A + p_B \leq p_1 + p_A$, hence scheduling p_1 and p_n on one machine and p_A and p_B on the other, cannot increase the Makespan.
- ▶ Repeat the above argument for the remaining machines.

Tight Example

- ▶ $2m + 1$ jobs
- ▶ 2 jobs with length $2m, 2m - 1, 2m - 2, \dots, m + 1$ ($2m - 2$ jobs in total)
- ▶ 3 jobs of length m

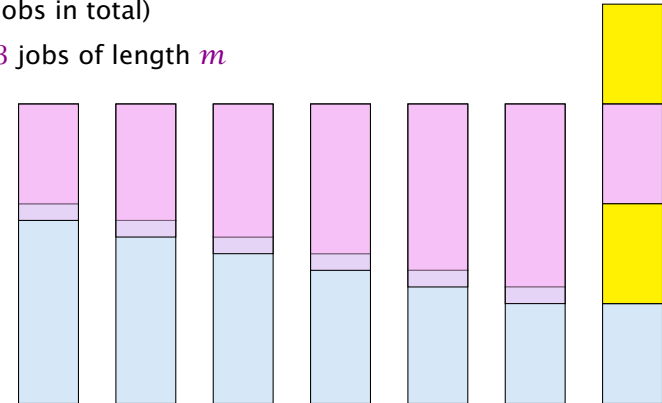

15 Rounding Data + Dynamic Programming

Knapsack:

Given a set of items $\{1, \dots, n\}$, where the i -th item has weight $w_i \in \mathbb{N}$ and profit $p_i \in \mathbb{N}$, and given a threshold W . Find a subset $I \subseteq \{1, \dots, n\}$ of items of total weight at most W such that the profit is maximized (we can assume each $w_i \leq W$).

$$\begin{array}{ll} \max & \sum_{i=1}^n p_i x_i \\ \text{s.t.} & \sum_{i=1}^n w_i x_i \leq W \\ & \forall i \in \{1, \dots, n\} \quad x_i \in \{0, 1\} \end{array}$$

15 Rounding Data + Dynamic Programming

Algorithm 1 Knapsack

```

1:  $A(1) \leftarrow [(0, 0), (p_1, w_1)]$ 
2: for  $j \leftarrow 2$  to  $n$  do
3:    $A(j) \leftarrow A(j - 1)$ 
4:   for each  $(p, w) \in A(j - 1)$  do
5:     if  $w + w_j \leq W$  then
6:       add  $(p + p_j, w + w_j)$  to  $A(j)$ 
7:     remove dominated pairs from  $A(j)$ 
8: return  $\max_{(p, w) \in A(n)} p$ 

```

The running time is $\mathcal{O}(n \cdot \min\{W, P\})$, where $P = \sum_i p_i$ is the total profit of all items. This is only **pseudo-polynomial**.

15 Rounding Data + Dynamic Programming

Definition 74

An algorithm is said to have pseudo-polynomial running time if the running time is polynomial when the numerical part of the input is encoded in unary.

15 Rounding Data + Dynamic Programming

- ▶ Let M be the maximum profit of an element.
- ▶ Set $\mu := \epsilon M/n$.
- ▶ Set $p'_i := \lfloor p_i/\mu \rfloor$ for all i .
- ▶ Run the dynamic programming algorithm on this revised instance.

Running time is at most

$$\mathcal{O}(nP') = \mathcal{O}\left(n \sum_i p'_i\right) = \mathcal{O}\left(n \sum_i \left\lfloor \frac{p_i}{\epsilon M/n} \right\rfloor\right) \leq \mathcal{O}\left(\frac{n^3}{\epsilon}\right).$$

15 Rounding Data + Dynamic Programming

Let S be the set of items returned by the algorithm, and let O be an optimum set of items.

$$\begin{aligned} \sum_{i \in S} p_i &\geq \mu \sum_{i \in S} p'_i \\ &\geq \mu \sum_{i \in O} p'_i \\ &\geq \sum_{i \in O} p_i - |O|\mu \\ &\geq \sum_{i \in O} p_i - n\mu \\ &= \sum_{i \in O} p_i - \epsilon M \\ &\geq (1 - \epsilon)\text{OPT}. \end{aligned}$$

Scheduling Revisited

The previous analysis of the scheduling algorithm gave a makespan of

$$\frac{1}{m} \sum_{j \neq \ell} p_j + p_\ell$$

where ℓ is the last job to complete.

Together with the observation that if each $p_i \geq \frac{1}{3}C_{\max}^*$ then LPT is optimal this gave a $4/3$ -approximation.

15.2 Scheduling Revisited

Partition the input into **long** jobs and **short** jobs.

A job j is called short if

$$p_j \leq \frac{1}{km} \sum_i p_i$$

Idea:

1. Find the optimum Makespan for the long jobs by brute force.
2. Then use the list scheduling algorithm for the short jobs, always assigning the next job to the least loaded machine.

We still have a cost of

$$\frac{1}{m} \sum_{j \neq \ell} p_j + p_\ell$$

where ℓ is the last job (this only requires that all machines are busy before time S_ℓ).

If ℓ is a long job, then the schedule must be optimal, as it consists of an optimal schedule of long jobs plus a schedule for short jobs.

If ℓ is a short job its length is at most

$$p_\ell \leq \sum_j p_j / (mk)$$

which is at most C_{\max}^* / k .

Hence we get a schedule of length at most

$$\left(1 + \frac{1}{k}\right) C_{\max}^*$$

There are at most km long jobs. Hence, the number of possibilities of scheduling these jobs on m machines is at most m^{km} , which is constant if m is constant. Hence, it is easy to implement the algorithm in polynomial time.

Theorem 75

The above algorithm gives a polynomial time approximation scheme (PTAS) for the problem of scheduling n jobs on m identical machines if m is constant.

We choose $k = \lceil \frac{1}{\epsilon} \rceil$.

How to get rid of the requirement that m is constant?

We first design an algorithm that works as follows:

On input of T it either finds a schedule of length $(1 + \frac{1}{k})T$ or certifies that no schedule of length at most T exists (assume $T \geq \frac{1}{m} \sum_j p_j$).

We partition the jobs into **long** jobs and **short** jobs:

- ▶ A job is long if its size is larger than T/k .
- ▶ Otw. it is a short job.

- ▶ We round all **long jobs** down to multiples of T/k^2 .
- ▶ For these rounded sizes we first find an optimal schedule.
- ▶ If this schedule does not have length at most T we conclude that also the original sizes don't allow such a schedule.
- ▶ If we have a good schedule we extend it by adding the short jobs according to the LPT rule.

After the first phase the rounded sizes of the long jobs assigned to a machine add up to at most T .

There can be at most k (long) jobs assigned to a machine as otherwise their rounded sizes would add up to more than T (note that the **rounded** size of a long job is at least T/k).

Since, jobs had been rounded to multiples of T/k^2 going from rounded sizes to original sizes gives that the Makespan is at most

$$\left(1 + \frac{1}{k}\right)T .$$

During the second phase there always must exist a machine with load at most T , since T is larger than the average load. Assigning the current (short) job to such a machine gives that the new load is at most

$$T + \frac{T}{k} \leq \left(1 + \frac{1}{k}\right)T .$$

Running Time for scheduling large jobs: There should not be a job with rounded size more than T as otherwise the problem becomes trivial.

Hence, any large job has rounded size of $\frac{i}{k^2}T$ for $i \in \{k, \dots, k^2\}$. Therefore the number of different inputs is at most n^{k^2} (described by a vector of length k^2 where, the i -th entry describes the number of jobs of size $\frac{i}{k^2}T$). **This is polynomial.**

The schedule/configuration of a particular machine x can be described by a vector of length k^2 where the i -th entry describes the number of jobs of rounded size $\frac{i}{k^2}T$ assigned to x . There are only $(k+1)^{k^2}$ different vectors.

This means there are a **constant** number of different machine configurations.

Let $\text{OPT}(n_1, \dots, n_{k^2})$ be the **number of machines** that are required to schedule input vector (n_1, \dots, n_{k^2}) with Makespan at most T .

If $\text{OPT}(n_1, \dots, n_{k^2}) \leq m$ we can schedule the input.

We have

$$\text{OPT}(n_1, \dots, n_{k^2}) = \begin{cases} 0 & (n_1, \dots, n_{k^2}) = 0 \\ 1 + \min_{(s_1, \dots, s_{k^2}) \in C} \text{OPT}(n_1 - s_1, \dots, n_{k^2} - s_{k^2}) & (n_1, \dots, n_{k^2}) \geq 0 \\ \infty & \text{otw.} \end{cases}$$

where C is the set of all configurations.

Hence, the running time is roughly $(k+1)^{k^2} n^{k^2} \approx (nk)^{k^2}$.

We can turn this into a PTAS by choosing $k = \lceil 1/\epsilon \rceil$ and using binary search. This gives a running time that is exponential in $1/\epsilon$.

Can we do better?

Scheduling on identical machines with the goal of minimizing Makespan is a **strongly NP-complete** problem.

Theorem 76

There is no FPTAS for problems that are strongly NP-hard.

- ▶ Suppose we have an instance with polynomially bounded processing times $p_i \leq q(n)$
- ▶ We set $k := \lceil 2nq(n) \rceil \geq 2 \text{OPT}$
- ▶ Then

$$\text{ALG} \leq \left(1 + \frac{1}{k}\right) \text{OPT} \leq \text{OPT} + \frac{1}{2}$$

- ▶ But this means that the algorithm computes the optimal solution as the optimum is integral.
- ▶ This means we can solve problem instances if processing times are polynomially bounded
- ▶ Running time is $\mathcal{O}(\text{poly}(n, k)) = \mathcal{O}(\text{poly}(n))$
- ▶ For strongly NP-complete problems this is not possible unless P=NP

More General

Let $\text{OPT}(n_1, \dots, n_A)$ be the number of machines that are required to schedule input vector (n_1, \dots, n_A) with Makespan at most T (A : **number of different sizes**).

If $\text{OPT}(n_1, \dots, n_A) \leq m$ we can schedule the input.

$$\text{OPT}(n_1, \dots, n_A) = \begin{cases} 0 & (n_1, \dots, n_A) = 0 \\ 1 + \min_{(s_1, \dots, s_A) \in C} \text{OPT}(n_1 - s_1, \dots, n_A - s_A) & (n_1, \dots, n_A) \geq 0 \\ \infty & \text{otw.} \end{cases}$$

where C is the set of all configurations.

$|C| \leq (B+1)^A$, where B is the **number of jobs that possibly can fit on the same machine**.

The **running time** is then $\mathcal{O}((B+1)^A n^A)$ because the dynamic programming table has just n^A entries.

Bin Packing

Given n items with sizes s_1, \dots, s_n where

$$1 > s_1 \geq \dots \geq s_n > 0.$$

Pack items into a minimum number of bins where each bin can hold items of total size at most 1.

Theorem 77

There is no ρ -approximation for Bin Packing with $\rho < 3/2$ unless $P = NP$.

Bin Packing

Proof

- ▶ In the partition problem we are given positive integers b_1, \dots, b_n with $B = \sum_i b_i$ even. Can we partition the integers into two sets S and T s.t.

$$\sum_{i \in S} b_i = \sum_{i \in T} b_i \quad ?$$

- ▶ We can solve this problem by setting $s_i := 2b_i/B$ and asking whether we can pack the resulting items into 2 bins or not.
- ▶ A ρ -approximation algorithm with $\rho < 3/2$ cannot output 3 or more bins when 2 are optimal.
- ▶ Hence, such an algorithm can solve Partition.

Bin Packing

Definition 78

An asymptotic polynomial-time approximation scheme (APTAS) is a family of algorithms $\{A_\epsilon\}$ along with a constant c such that A_ϵ returns a solution of value at most $(1 + \epsilon)\text{OPT} + c$ for minimization problems.

- ▶ Note that for Set Cover or for Knapsack it makes no sense to differentiate between the notion of a PTAS or an APTAS because of scaling.
- ▶ However, we will develop an APTAS for Bin Packing.

Bin Packing

Again we can differentiate between small and large items.

Lemma 79

Any packing of items into ℓ bins can be extended with items of size at most γ s.t. we use only $\max\{\ell, \frac{1}{1-\gamma}\text{SIZE}(I) + 1\}$ bins, where $\text{SIZE}(I) = \sum_i s_i$ is the sum of all item sizes.

- ▶ If after Greedy we use more than ℓ bins, all bins (apart from the last) must be full to at least $1 - \gamma$.
- ▶ Hence, $r(1 - \gamma) \leq \text{SIZE}(I)$ where r is the number of nearly-full bins.
- ▶ This gives the lemma.

Choose $\gamma = \epsilon/2$. Then we either use ℓ bins or at most

$$\frac{1}{1 - \epsilon/2} \cdot \text{OPT} + 1 \leq (1 + \epsilon) \cdot \text{OPT} + 1$$

bins.

It remains to find an algorithm for the large items.

Bin Packing

Linear Grouping:

Generate an instance I' (for large items) as follows.

- ▶ Order large items according to size.
- ▶ Let the first k items belong to group 1; the following k items belong to group 2; etc.
- ▶ Delete items in the first group;
- ▶ Round items in the remaining groups to the size of the largest item in the group.

Linear Grouping

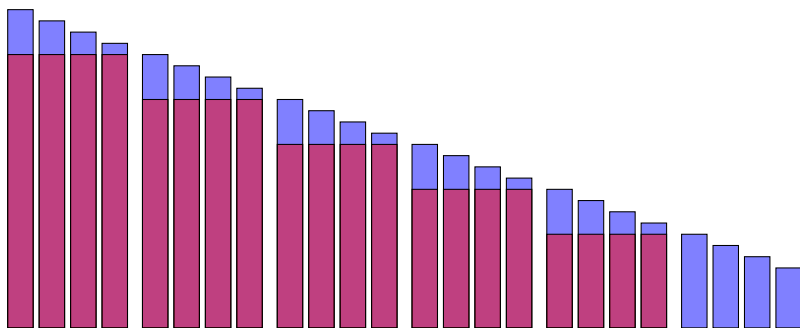

Lemma 80

$$\text{OPT}(I') \leq \text{OPT}(I) \leq \text{OPT}(I') + k$$

Proof 1:

- ▶ Any bin packing for I gives a bin packing for I' as follows.
- ▶ Pack the items of group 2, where in the packing for I the items for group 1 have been packed;
- ▶ Pack the items of groups 3, where in the packing for I the items for group 2 have been packed;
- ▶ ...

Lemma 81

$$\text{OPT}(I') \leq \text{OPT}(I) \leq \text{OPT}(I') + k$$

Proof 2:

- ▶ Any bin packing for I' gives a bin packing for I as follows.
- ▶ Pack the items of group 1 into k new bins;
- ▶ Pack the items of groups 2, where in the packing for I' the items for group 2 have been packed;
- ▶ ...

Assume that our instance does not contain pieces smaller than $\epsilon/2$. Then $\text{SIZE}(I) \geq \epsilon n/2$.

We set $k = \lfloor \epsilon \text{SIZE}(I) \rfloor$.

Then $n/k \leq n/\lfloor \epsilon^2 n/2 \rfloor \leq 4/\epsilon^2$ (note that $\lfloor \alpha \rfloor \geq \alpha/2$ for $\alpha \geq 1$).

Hence, after grouping we have a constant number of piece sizes ($4/\epsilon^2$) and at most a constant number ($2/\epsilon$) can fit into any bin.

We can find an optimal packing for such instances by the previous Dynamic Programming approach.

- ▶ cost (for large items) at most

$$\text{OPT}(I') + k \leq \text{OPT}(I) + \epsilon \text{SIZE}(I) \leq (1 + \epsilon) \text{OPT}(I)$$

- ▶ running time $\mathcal{O}((\frac{2}{\epsilon}n)^{4/\epsilon^2})$.

Can we do better?

In the following we show how to obtain a solution where the number of bins is only

$$\text{OPT}(I) + \mathcal{O}(\log^2(\text{SIZE}(I))) .$$

Note that this is usually better than a guarantee of

$$(1 + \epsilon) \text{OPT}(I) + 1 .$$

Configuration LP

Change of Notation:

- ▶ Group pieces of identical size.
- ▶ Let s_1 denote the largest size, and let b_1 denote the number of pieces of size s_1 .
- ▶ s_2 is second largest size and b_2 number of pieces of size s_2 ;
- ▶ ...
- ▶ s_m smallest size and b_m number of pieces of size s_m .

Configuration LP

A possible packing of a bin can be described by an m -tuple (t_1, \dots, t_m) , where t_i describes the number of pieces of size s_i . Clearly,

$$\sum_i t_i \cdot s_i \leq 1 .$$

We call a vector that fulfills the above constraint a **configuration**.

Configuration LP

Let N be the number of configurations (**exponential**).

Let T_1, \dots, T_N be the sequence of all possible configurations (a configuration T_j has T_{ji} pieces of size s_i).

$$\begin{array}{ll} \min & \sum_{j=1}^N x_j \\ \text{s.t.} & \forall i \in \{1 \dots m\} \quad \sum_{j=1}^N T_{ji} x_j \geq b_i \\ & \forall j \in \{1, \dots, N\} \quad x_j \geq 0 \\ & \forall j \in \{1, \dots, N\} \quad x_j \text{ integral} \end{array}$$

How to solve this LP?

later...

We can assume that each item has size at least $1/\text{SIZE}(I)$.

Harmonic Grouping

- ▶ Sort items according to size (monotonically decreasing).
- ▶ Process items in this order; close the current group if size of items in the group is at least 2 (or larger). Then open new group.
- ▶ I.e., G_1 is the smallest cardinality set of largest items s.t. total size sums up to at least 2. Similarly, for G_2, \dots, G_{r-1} .
- ▶ Only the size of items in the last group G_r may sum up to less than 2.

Harmonic Grouping

From the grouping we obtain instance I' as follows:

- ▶ Round all items in a group to the size of the largest group member.
- ▶ Delete all items from group G_1 and G_r .
- ▶ For groups G_2, \dots, G_{r-1} delete $n_i - n_{i-1}$ items.
- ▶ Observe that $n_i \geq n_{i-1}$.

Lemma 82

The number of different sizes in I' is at most $\text{SIZE}(I)/2$.

- ▶ Each group that survives (recall that G_1 and G_r are deleted) has total size at least 2.
- ▶ Hence, the number of surviving groups is at most $\text{SIZE}(I)/2$.
- ▶ All items in a group have the same size in I' .

Lemma 83

The total size of deleted items is at most $\mathcal{O}(\log(\text{SIZE}(I)))$.

- ▶ The total size of items in G_1 and G_r is at most 6 as a group has total size at most 3.
- ▶ Consider a group G_i that has strictly more items than G_{i-1} .
- ▶ It discards $n_i - n_{i-1}$ pieces of total size at most

$$3 \frac{n_i - n_{i-1}}{n_i} \leq \sum_{j=n_{i-1}+1}^{n_i} \frac{3}{j}$$

since the average piece size is only $3/n_i$.

- ▶ Summing over all i that have $n_i > n_{i-1}$ gives a bound of at most

$$\sum_{j=1}^{n_{r-1}} \frac{3}{j} \leq \mathcal{O}(\log(\text{SIZE}(I))) .$$

(note that $n_r \leq \text{SIZE}(I)$ since we assume that the size of each item is at least $1/\text{SIZE}(I)$).

Algorithm 1 BinPack

- 1: **if** $\text{SIZE}(I) < 10$ **then**
- 2: pack remaining items greedily
- 3: Apply harmonic grouping to create instance I' ; pack discarded items in at most $\mathcal{O}(\log(\text{SIZE}(I)))$ bins.
- 4: Let x be optimal solution to configuration LP
- 5: Pack $\lfloor x_j \rfloor$ bins in configuration T_j for all j ; call the packed instance I_1 .
- 6: Let I_2 be remaining pieces from I'
- 7: Pack I_2 via BinPack(I_2)

Analysis

$$\text{OPT}_{\text{LP}}(I_1) + \text{OPT}_{\text{LP}}(I_2) \leq \text{OPT}_{\text{LP}}(I') \leq \text{OPT}_{\text{LP}}(I)$$

Proof:

- ▶ Each piece surviving in I' can be mapped to a piece in I of no lesser size. Hence, $\text{OPT}_{\text{LP}}(I') \leq \text{OPT}_{\text{LP}}(I)$
- ▶ $\lfloor x_j \rfloor$ is feasible solution for I_1 (even integral).
- ▶ $x_j - \lfloor x_j \rfloor$ is feasible solution for I_2 .

Analysis

Each level of the recursion partitions pieces into three types

1. Pieces discarded at this level.
2. Pieces scheduled because they are in I_1 .
3. Pieces in I_2 are handed down to the next level.

Pieces of type 2 summed over all recursion levels are packed into at most OPT_{LP} many bins.

Pieces of type 1 are packed into at most

$$\mathcal{O}(\log(\text{SIZE}(I))) \cdot L$$

many bins where L is the number of recursion levels.

Analysis

We can show that $\text{SIZE}(I_2) \leq \text{SIZE}(I)/2$. Hence, the number of recursion levels is only $\mathcal{O}(\log(\text{SIZE}(I_{\text{original}})))$ in total.

- ▶ The number of non-zero entries in the solution to the configuration LP for I' is at most the number of constraints, which is the number of different sizes ($\leq \text{SIZE}(I)/2$).
- ▶ The total size of items in I_2 can be at most $\sum_{j=1}^N x_j - \lfloor x_j \rfloor$ which is at most the number of non-zero entries in the solution to the configuration LP.

How to solve the LP?

Let T_1, \dots, T_N be the sequence of all possible configurations (a configuration T_j has T_{ji} pieces of size s_i).
In total we have b_i pieces of size s_i .

Primal

$$\begin{array}{ll} \min & \sum_{j=1}^N x_j \\ \text{s.t.} & \forall i \in \{1 \dots m\} \quad \sum_{j=1}^N T_{ji} x_j \geq b_i \\ & \forall j \in \{1, \dots, N\} \quad x_j \geq 0 \end{array}$$

Dual

$$\begin{array}{ll} \max & \sum_{i=1}^m y_i b_i \\ \text{s.t.} & \forall j \in \{1, \dots, N\} \quad \sum_{i=1}^m T_{ji} y_i \leq 1 \\ & \forall i \in \{1, \dots, m\} \quad y_i \geq 0 \end{array}$$

Separation Oracle

Suppose that I am given variable assignment y for the dual.

How do I find a violated constraint?

I have to find a configuration $T_j = (T_{j1}, \dots, T_{jm})$ that

- ▶ is feasible, i.e.,

$$\sum_{i=1}^m T_{ji} \cdot s_i \leq 1,$$

- ▶ and has a large profit

$$\sum_{i=1}^m T_{ji} y_i > 1$$

But this is the Knapsack problem.

Separation Oracle

We have FPTAS for Knapsack. This means if a constraint is violated with $1 + \epsilon' = 1 + \frac{\epsilon}{1-\epsilon}$ we find it, since we can obtain at least $(1 - \epsilon)$ of the optimal profit.

The solution we get is feasible for:

Dual'

$$\begin{array}{ll} \max & \sum_{i=1}^m y_i b_i \\ \text{s.t.} & \forall j \in \{1, \dots, N\} \quad \sum_{i=1}^m T_{ji} y_i \leq 1 + \epsilon' \\ & \forall i \in \{1, \dots, m\} \quad y_i \geq 0 \end{array}$$

Primal'

$$\begin{array}{ll} \min & (1 + \epsilon') \sum_{j=1}^N x_j \\ \text{s.t.} & \forall i \in \{1 \dots m\} \quad \sum_{j=1}^N T_{ji} x_j \geq b_i \\ & \forall j \in \{1, \dots, N\} \quad x_j \geq 0 \end{array}$$

Separation Oracle

If the value of the computed dual solution (which may be infeasible) is z then

$$\text{OPT} \leq z \leq (1 + \epsilon') \text{OPT}$$

How do we get good primal solution (not just the value)?

- ▶ The constraints used when computing z **certify** that the solution is feasible for **DUAL'**.
- ▶ Suppose that we drop all unused constraints in **DUAL**. We will compute the same solution feasible for **DUAL'**.
- ▶ Let **DUAL''** be **DUAL** without unused constraints.
- ▶ The dual to **DUAL''** is **PRIMAL** where we ignore variables for which the corresponding dual constraint has not been used.
- ▶ The optimum value for **PRIMAL''** is at most $(1 + \epsilon') \text{OPT}$.
- ▶ We can compute the corresponding solution in polytime.

This gives that overall we need at most

$$(1 + \epsilon') \text{OPT}_{\text{LP}}(I) + \mathcal{O}(\log^2(\text{SIZE}(I)))$$

bins.

We can choose $\epsilon' = \frac{1}{\text{OPT}}$ as $\text{OPT} \leq \# \text{items}$ and since we have a **fully polynomial time approximation scheme (FPTAS)** for knapsack.

Lemma 84 (Chernoff Bounds)

Let X_1, \dots, X_n be n **independent** 0-1 random variables, not necessarily identically distributed. Then for $X = \sum_{i=1}^n X_i$ and $\mu = E[X]$, $L \leq \mu \leq U$, and $\delta > 0$

$$\Pr[X \geq (1 + \delta)U] < \left(\frac{e^\delta}{(1 + \delta)^{1+\delta}} \right)^U,$$

and

$$\Pr[X \leq (1 - \delta)L] < \left(\frac{e^{-\delta}}{(1 - \delta)^{1-\delta}} \right)^L,$$

Lemma 85

For $0 \leq \delta \leq 1$ we have that

$$\left(\frac{e^\delta}{(1 + \delta)^{1+\delta}} \right)^U \leq e^{-U\delta^2/3}$$

and

$$\left(\frac{e^{-\delta}}{(1 - \delta)^{1-\delta}} \right)^L \leq e^{-L\delta^2/2}$$

Proof of Chernoff Bounds

Markov's Inequality:

Let X be random variable taking non-negative values.

Then

$$\Pr[X \geq a] \leq E[X]/a$$

Trivial!

Proof of Chernoff Bounds

Hence:

$$\Pr[X \geq (1 + \delta)U] \leq \frac{E[X]}{(1 + \delta)U} \approx \frac{1}{1 + \delta}$$

That's awfully weak :(

Proof of Chernoff Bounds

Set $p_i = \Pr[X_i = 1]$. Assume $p_i > 0$ for all i .

Cool Trick:

$$\Pr[X \geq (1 + \delta)U] = \Pr[e^{tX} \geq e^{t(1+\delta)U}]$$

Now, we apply Markov:

$$\Pr[e^{tX} \geq e^{t(1+\delta)U}] \leq \frac{E[e^{tX}]}{e^{t(1+\delta)U}}.$$

This may be a lot better (!?)

Proof of Chernoff Bounds

$$E[e^{tX}] = E[e^{t \sum_i X_i}] = E[\prod_i e^{tX_i}] = \prod_i E[e^{tX_i}]$$

$$E[e^{tX_i}] = (1 - p_i) + p_i e^t = 1 + p_i(e^t - 1) \leq e^{p_i(e^t - 1)}$$

$$\prod_i E[e^{tX_i}] \leq \prod_i e^{p_i(e^t - 1)} = e^{\sum p_i(e^t - 1)} = e^{(e^t - 1)U}$$

Now, we apply Markov:

$$\begin{aligned} \Pr[X \geq (1 + \delta)U] &= \Pr[e^{tX} \geq e^{t(1+\delta)U}] \\ &\leq \frac{E[e^{tX}]}{e^{t(1+\delta)U}} \leq \frac{e^{(e^t - 1)U}}{e^{t(1+\delta)U}} \leq \left(\frac{e^\delta}{(1 + \delta)^{1+\delta}} \right)^U \end{aligned}$$

We choose $t = \ln(1 + \delta)$.

Lemma 86

For $0 \leq \delta \leq 1$ we have that

$$\left(\frac{e^\delta}{(1+\delta)^{1+\delta}} \right)^U \leq e^{-U\delta^2/3}$$

and

$$\left(\frac{e^{-\delta}}{(1-\delta)^{1-\delta}} \right)^L \leq e^{-L\delta^2/2}$$

Show:

$$\left(\frac{e^\delta}{(1+\delta)^{1+\delta}} \right)^U \leq e^{-U\delta^2/3}$$

Take logarithms:

$$U(\delta - (1+\delta)\ln(1+\delta)) \leq -U\delta^2/3$$

True for $\delta = 0$. Divide by U and take derivatives:

$$-\ln(1+\delta) \leq -2\delta/3$$

Reason:

As long as derivative of left side is smaller than derivative of right side the inequality holds.

$$f(\delta) := -\ln(1+\delta) + 2\delta/3 \leq 0$$

A convex function ($f''(\delta) \geq 0$) on an interval takes maximum at the boundaries.

$$f'(\delta) = -\frac{1}{1+\delta} + 2/3 \quad f''(\delta) = \frac{1}{(1+\delta)^2}$$

$$f(0) = 0 \text{ and } f(1) = -\ln(2) + 2/3 < 0$$

For $\delta \geq 1$ we show

$$\left(\frac{e^\delta}{(1+\delta)^{1+\delta}} \right)^U \leq e^{-U\delta/3}$$

Take logarithms:

$$U(\delta - (1+\delta)\ln(1+\delta)) \leq -U\delta/3$$

True for $\delta = 0$. Divide by U and take derivatives:

$$-\ln(1+\delta) \leq -1/3 \iff \ln(1+\delta) \geq 1/3 \quad (\text{true})$$

Reason:

As long as derivative of left side is smaller than derivative of right side the inequality holds.

Show:

$$\left(\frac{e^{-\delta}}{(1-\delta)^{1-\delta}} \right)^L \leq e^{-L\delta^2/2}$$

Take logarithms:

$$L(-\delta - (1-\delta)\ln(1-\delta)) \leq -L\delta^2/2$$

True for $\delta = 0$. Divide by L and take derivatives:

$$\ln(1-\delta) \leq -\delta$$

Reason:

As long as derivative of left side is smaller than derivative of right side the inequality holds.

$$\ln(1-\delta) \leq -\delta$$

True for $\delta = 0$. Take derivatives:

$$-\frac{1}{1-\delta} \leq -1$$

This holds for $0 \leq \delta < 1$.

Integer Multicommodity Flows

- ▶ Given s_i-t_i pairs in a graph.
- ▶ Connect each pair by a path such that not too many path use any given edge.

$$\begin{array}{ll} \min & W \\ \text{s.t.} & \forall i \quad \sum_{p \in \mathcal{P}_i} x_p = 1 \\ & \sum_{p: e \in p} x_p \leq W \\ & x_p \in \{0, 1\} \end{array}$$

Integer Multicommodity Flows

Randomized Rounding:

For each i choose one path from the set \mathcal{P}_i at random according to the probability distribution given by the Linear Programming solution.

Theorem 87

If $W^* \geq c \ln n$ for some constant c , then with probability at least $1 - n^{-c/3}$ the total number of paths using any edge is at most $W^* + \sqrt{cW^* \ln n} = \mathcal{O}(W^*)$.

Theorem 88

With probability at least $1 - n^{-c/3}$ the total number of paths using any edge is at most $\mathcal{O}(W^* + c \ln n)$.

Integer Multicommodity Flows

Let X_e^i be a random variable that indicates whether the path for s_i-t_i uses edge e .

Then the number of paths using edge e is $Y_e = \sum_i X_e^i$.

$$E[Y_e] = \sum_i \sum_{p \in \mathcal{P}_i: e \in p} x_p^* = \sum_{p: e \in p} x_p^* \leq W^*$$

Integer Multicommodity Flows

Choose $\delta = \sqrt{(c \ln n)/W^*}$.

Then

$$\Pr[Y_e \geq (1 + \delta)W^*] < e^{-W^* \delta^2/3} = \frac{1}{n^{c/3}}$$

16.3 MAXSAT

Problem definition:

- ▶ n Boolean variables
- ▶ m clauses C_1, \dots, C_m . For example

$$C_7 = x_3 \vee \bar{x}_5 \vee \bar{x}_9$$

- ▶ Non-negative weight w_j for each clause C_j .
- ▶ Find an assignment of true/false to the variables such that the total weight of clauses that are **satisfied** is maximum.

16.3 MAXSAT

Terminology:

- ▶ A variable x_i and its negation \bar{x}_i are called **literals**.
- ▶ Hence, each clause consists of a set of literals (i.e., no duplications: $x_i \vee x_i \vee \bar{x}_j$ is **not** a clause).
- ▶ We assume a clause does not contain x_i and \bar{x}_i for any i .
- ▶ x_i is called a **positive literal** while the negation \bar{x}_i is called a **negative literal**.
- ▶ For a given clause C_j the number of its literals is called its **length** or **size** and denoted with ℓ_j .
- ▶ Clauses of length one are called **unit clauses**.

MAXSAT: Flipping Coins

Set each x_i independently to **true** with probability $\frac{1}{2}$ (and, hence, to **false** with probability $\frac{1}{2}$, as well).

Define random variable X_j with

$$X_j = \begin{cases} 1 & \text{if } C_j \text{ satisfied} \\ 0 & \text{otw.} \end{cases}$$

Then the total weight W of satisfied clauses is given by

$$W = \sum_j w_j X_j$$

$$\begin{aligned} E[W] &= \sum_j w_j E[X_j] \\ &= \sum_j w_j \Pr[C_j \text{ is satisfied}] \\ &= \sum_j w_j \left(1 - \left(\frac{1}{2}\right)^{\ell_j}\right) \\ &\geq \frac{1}{2} \sum_j w_j \\ &\geq \frac{1}{2} \text{OPT} \end{aligned}$$

MAXSAT: LP formulation

- ▶ Let for a clause C_j , P_j be the set of positive literals and N_j the set of negative literals.

$$C_j = \bigvee_{i \in P_j} x_i \vee \bigvee_{i \in N_j} \bar{x}_i$$

$$\begin{array}{ll} \max & \sum_j w_j z_j \\ \text{s.t.} & \forall j \quad \sum_{i \in P_j} y_i + \sum_{i \in N_j} (1 - y_i) \geq z_j \\ & \forall i \quad y_i \in \{0, 1\} \\ & \forall j \quad z_j \leq 1 \end{array}$$

MAXSAT: Randomized Rounding

Set each x_i independently to **true** with probability y_i (and, hence, to **false** with probability $(1 - y_i)$).

Lemma 89 (Geometric Mean \leq Arithmetic Mean)

For any nonnegative a_1, \dots, a_k

$$\left(\prod_{i=1}^k a_i \right)^{1/k} \leq \frac{1}{k} \sum_{i=1}^k a_i$$

Definition 90

A function f on an interval I is **concave** if for any two points s and r from I and any $\lambda \in [0, 1]$ we have

$$f(\lambda s + (1 - \lambda)r) \geq \lambda f(s) + (1 - \lambda)f(r)$$

Lemma 91

Let f be a concave function on the interval $[0, 1]$, with $f(0) = a$ and $f(1) = a + b$. Then

$$\begin{aligned} f(\lambda) &= f((1 - \lambda)0 + \lambda 1) \\ &\geq (1 - \lambda)f(0) + \lambda f(1) \\ &= a + \lambda b \end{aligned}$$

for $\lambda \in [0, 1]$.

$$\begin{aligned}
\Pr[C_j \text{ not satisfied}] &= \prod_{i \in P_j} (1 - y_i) \prod_{i \in N_j} y_i \\
&\leq \left[\frac{1}{\ell_j} \left(\sum_{i \in P_j} (1 - y_i) + \sum_{i \in N_j} y_i \right) \right]^{\ell_j} \\
&= \left[1 - \frac{1}{\ell_j} \left(\sum_{i \in P_j} y_i + \sum_{i \in N_j} (1 - y_i) \right) \right]^{\ell_j} \\
&\leq \left(1 - \frac{z_j}{\ell_j} \right)^{\ell_j} .
\end{aligned}$$

The function $f(z) = 1 - (1 - \frac{z}{\ell})^\ell$ is concave. Hence,

$$\begin{aligned}
\Pr[C_j \text{ satisfied}] &\geq 1 - \left(1 - \frac{z_j}{\ell_j} \right)^{\ell_j} \\
&\geq \left[1 - \left(1 - \frac{1}{\ell_j} \right)^{\ell_j} \right] \cdot z_j .
\end{aligned}$$

$f''(z) = -\frac{\ell-1}{\ell} \left[1 - \frac{z}{\ell} \right]^{\ell-2} \leq 0$ for $z \in [0, 1]$. Therefore, f is concave.

$$\begin{aligned}
E[W] &= \sum_j w_j \Pr[C_j \text{ is satisfied}] \\
&\geq \sum_j w_j z_j \left[1 - \left(1 - \frac{1}{\ell_j} \right)^{\ell_j} \right] \\
&\geq \left(1 - \frac{1}{e} \right) \text{OPT} .
\end{aligned}$$

MAXSAT: The better of two

Theorem 92

Choosing the better of the two solutions given by randomized rounding and coin flipping yields a $\frac{3}{4}$ -approximation.

Let W_1 be the value of randomized rounding and W_2 the value obtained by coin flipping.

$$\begin{aligned}
 E[\max\{W_1, W_2\}] &\geq E\left[\frac{1}{2}W_1 + \frac{1}{2}W_2\right] \\
 &\geq \frac{1}{2} \sum_j w_j z_j \left[1 - \left(1 - \frac{1}{\ell_j}\right)^{\ell_j}\right] + \frac{1}{2} \sum_j w_j \left(1 - \left(\frac{1}{2}\right)^{\ell_j}\right) \\
 &\geq \sum_j w_j z_j \underbrace{\left[\frac{1}{2} \left(1 - \left(1 - \frac{1}{\ell_j}\right)^{\ell_j}\right) + \frac{1}{2} \left(1 - \left(\frac{1}{2}\right)^{\ell_j}\right)\right]}_{\geq \frac{3}{4} \text{ for all integers}} \\
 &\geq \frac{3}{4} \text{OPT}
 \end{aligned}$$

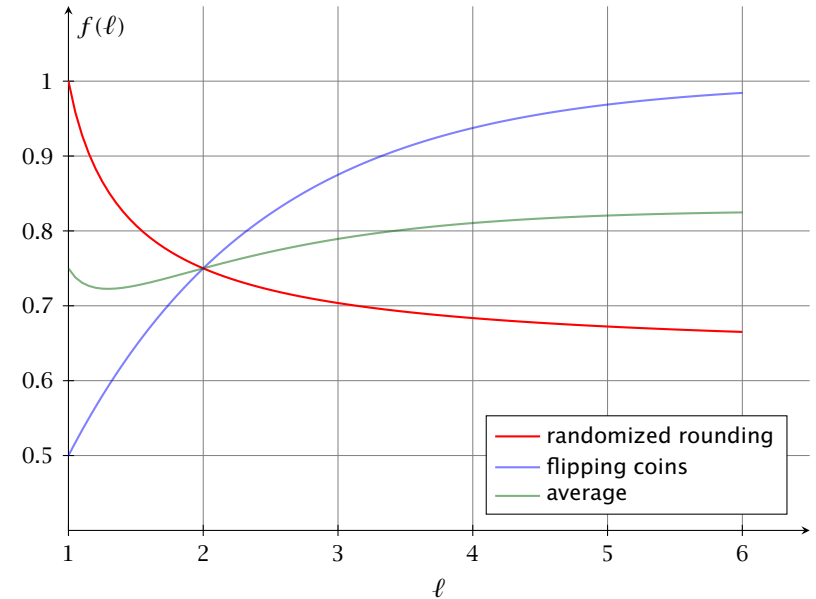

MAXSAT: Nonlinear Randomized Rounding

So far we used **linear** randomized rounding, i.e., the probability that a variable is set to 1/true was exactly the value of the corresponding variable in the linear program.

We could define a function $f : [0, 1] \rightarrow [0, 1]$ and set x_i to true with probability $f(y_i)$.

MAXSAT: Nonlinear Randomized Rounding

Let $f : [0, 1] \rightarrow [0, 1]$ be a function with

$$1 - 4^{-x} \leq f(x) \leq 4^{x-1}$$

Theorem 93

Rounding the LP-solution with a function f of the above form gives a $\frac{3}{4}$ -approximation.

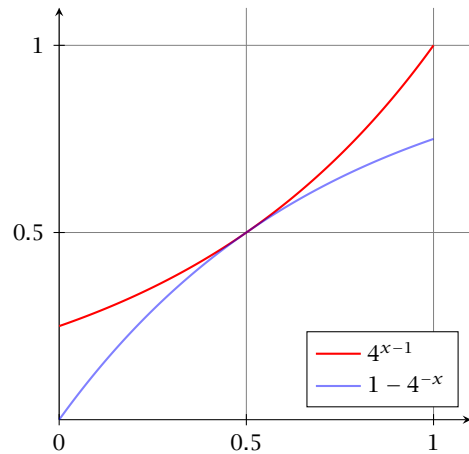

$$\begin{aligned}
 \Pr[C_j \text{ not satisfied}] &= \prod_{i \in P_j} (1 - f(y_i)) \prod_{i \in N_j} f(y_i) \\
 &\leq \prod_{i \in P_j} 4^{-y_i} \prod_{i \in N_j} 4^{y_i - 1} \\
 &= 4^{-(\sum_{i \in P_j} y_i + \sum_{i \in N_j} (1 - y_i))} \\
 &\leq 4^{-z_j}
 \end{aligned}$$

The function $g(z) = 1 - 4^{-z}$ is concave on $[0, 1]$. Hence,

$$\Pr[C_j \text{ satisfied}] \geq 1 - 4^{-z_j} \geq \frac{3}{4}z_j.$$

Therefore,

$$E[W] = \sum_j w_j \Pr[C_j \text{ satisfied}] \geq \frac{3}{4} \sum_j w_j z_j \geq \frac{3}{4} \text{OPT}$$

Can we do better?

Not if we compare ourselves to the value of an optimum LP-solution.

Definition 94 (Integrality Gap)

The integrality gap for an ILP is the worst-case ratio over all instances of the problem of the value of an optimal IP-solution to the value of an optimal solution to its linear programming relaxation.

Note that the integrality is less than one for maximization problems and larger than one for minimization problems (of course, equality is possible).

Note that an integrality gap only holds for one specific ILP formulation.

Lemma 95

Our ILP-formulation for the MAXSAT problem has integrality gap at most $\frac{3}{4}$.

$$\begin{array}{ll}
\max & \sum_j w_j z_j \\
\text{s.t.} & \forall j \quad \sum_{i \in P_j} y_i + \sum_{i \in N_j} (1 - y_i) \geq z_j \\
& \forall i \quad y_i \in \{0, 1\} \\
& \forall j \quad z_j \leq 1
\end{array}$$

Consider: $(x_1 \vee x_2) \wedge (\bar{x}_1 \vee x_2) \wedge (x_1 \vee \bar{x}_2) \wedge (\bar{x}_1 \vee \bar{x}_2)$

- ▶ any solution can satisfy at most 3 clauses
- ▶ we can set $y_1 = y_2 = 1/2$ in the LP; this allows to set $z_1 = z_2 = z_3 = z_4 = 1$
- ▶ hence, the LP has value 4.

MaxCut

MaxCut

Given a weighted graph $G = (V, E, w)$, $w(v) \geq 0$, partition the vertices into two parts. Maximize the weight of edges between the parts.

Trivial 2-approximation

Semidefinite Programming

$$\begin{array}{ll}
\max / \min & \sum_{i,j} c_{ij} x_{ij} \\
\text{s.t.} & \forall k \quad \sum_{i,j} a_{ijk} x_{ij} = b_k \\
& \forall i, j \quad x_{ij} = x_{ji} \\
& X = (x_{ij}) \text{ is psd.}
\end{array}$$

- ▶ linear objective, linear constraints
- ▶ we can constrain a square matrix of variables to be symmetric positive definite

Note that wlog. we can assume that all variables appear in this matrix. Suppose we have a non-negative scalar z and want to express something like

$$\sum_{i,j} a_{ijk} x_{ij} + z = b_k$$

where x_{ij} are variables of the positive semidefinite matrix. We can add z as a diagonal entry $x_{\ell\ell}$, and additionally introduce constraints $x_{\ell r} = 0$ and $x_{r\ell} = 0$.

Vector Programming

$$\begin{array}{ll}
\max / \min & \sum_{i,j} c_{ij} (v_i^t v_j) \\
\text{s.t.} & \forall k \quad \sum_{i,j} a_{ijk} (v_i^t v_j) = b_k \\
& v_i \in \mathbb{R}^n
\end{array}$$

- ▶ variables are vectors in n -dimensional space
- ▶ objective functions and constraints are linear in inner products of the vectors

This is equivalent!

Fact [without proof]

We (essentially) can solve Semidefinite Programs in polynomial time...

Quadratic Programs

Quadratic Program for MaxCut:

$$\begin{array}{ll} \max & \frac{1}{2} \sum_{i,j} w_{ij} (1 - y_i y_j) \\ \forall i & y_i \in \{-1, 1\} \end{array}$$

This is exactly MaxCut!

Semidefinite Relaxation

$$\begin{array}{ll} \max & \frac{1}{2} \sum_{i,j} w_{ij} (1 - v_i^t v_j) \\ \forall i & v_i^t v_i = 1 \\ \forall i & v_i \in \mathbb{R}^n \end{array}$$

- ▶ this is clearly a relaxation
- ▶ the solution will be vectors on the unit sphere

Rounding the SDP-Solution

- ▶ Choose a random vector r such that $r/\|r\|$ is uniformly distributed on the unit sphere.
- ▶ If $r^t v_i > 0$ set $y_i = 1$ else set $y_i = -1$

Rounding the SDP-Solution

Choose the i -th coordinate r_i as a Gaussian with mean 0 and variance 1, i.e., $r_i \sim \mathcal{N}(0, 1)$.

Density function:

$$\varphi(x) = \frac{1}{\sqrt{2\pi}} e^{-x^2/2}$$

Then

$$\begin{aligned} \Pr[r = (x_1, \dots, x_n)] &= \frac{1}{(\sqrt{2\pi})^n} e^{-x_1^2/2} \cdot e^{-x_2^2/2} \cdot \dots \cdot e^{-x_n^2/2} dx_1 \cdot \dots \cdot dx_n \\ &= \frac{1}{(\sqrt{2\pi})^n} e^{-\frac{1}{2}(x_1^2 + \dots + x_n^2)} dx_1 \cdot \dots \cdot dx_n \end{aligned}$$

Hence the probability for a point only depends on its distance to the origin.

Rounding the SDP-Solution

Fact

The projection of r onto two unit vectors e_1 and e_2 are independent and are normally distributed with mean 0 and variance 1 iff e_1 and e_2 are orthogonal.

Note that this is clear if e_1 and e_2 are standard basis vectors.

Rounding the SDP-Solution

Corollary

If we project r onto a hyperplane its normalized projection ($r' / \|r'\|$) is uniformly distributed on the unit circle within the hyperplane.

Rounding the SDP-Solution

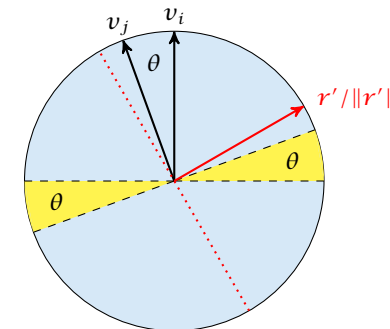

- ▶ if the normalized projection falls into the shaded region, v_i and v_j are rounded to different values
- ▶ this happens with probability θ/π

Rounding the SDP-Solution

- ▶ contribution of edge (i, j) to the SDP-relaxation:

$$\frac{1}{2} w_{ij} (1 - v_i^t v_j)$$

- ▶ (expected) contribution of edge (i, j) to the rounded instance $w_{ij} \arccos(v_i^t v_j) / \pi$
- ▶ ratio is at most

$$\min_{x \in [-1, 1]} \frac{2 \arccos(x)}{\pi(1-x)} \geq 0.878$$

Rounding the SDP-Solution

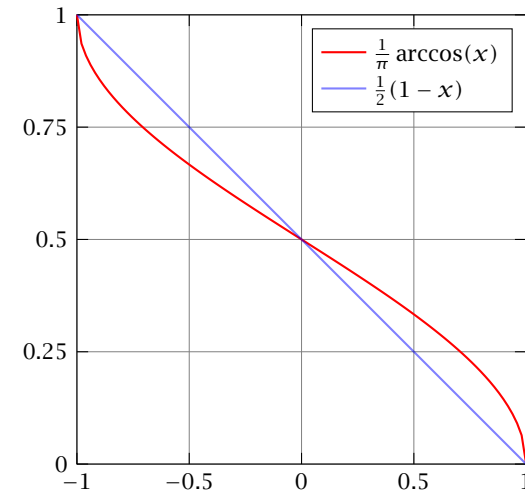

Rounding the SDP-Solution

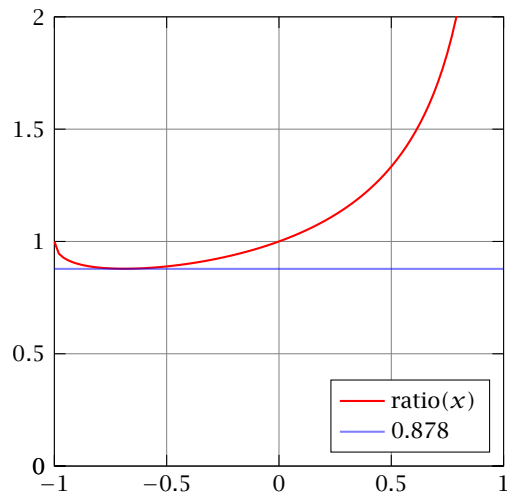

Rounding the SDP-Solution

Theorem 96

Given the unique games conjecture, there is no α -approximation for the maximum cut problem with constant

$$\alpha > \min_{x \in [-1, 1]} \frac{2 \arccos(x)}{\pi(1-x)}$$

unless $P = NP$.

Repetition: Primal Dual for Set Cover

Primal Relaxation:

$$\begin{array}{ll} \min & \sum_{i=1}^k w_i x_i \\ \text{s.t.} & \forall u \in U \quad \sum_{i:u \in S_i} x_i \geq 1 \\ & \forall i \in \{1, \dots, k\} \quad x_i \geq 0 \end{array}$$

Dual Formulation:

$$\begin{array}{ll} \max & \sum_{u \in U} y_u \\ \text{s.t.} & \forall i \in \{1, \dots, k\} \quad \sum_{u:u \in S_i} y_u \leq w_i \\ & y_u \geq 0 \end{array}$$

Repetition: Primal Dual for Set Cover

Algorithm:

- ▶ Start with $y = 0$ (feasible dual solution).
Start with $x = 0$ (integral primal solution that may be infeasible).
- ▶ While x not feasible
 - ▶ Identify an element e that is not covered in current primal integral solution.
 - ▶ Increase dual variable y_e until a dual constraint becomes tight (maybe increase by 0!).
 - ▶ If this is the constraint for set S_j set $x_j = 1$ (add this set to your solution).

Repetition: Primal Dual for Set Cover

Analysis:

- ▶ For every set S_j with $x_j = 1$ we have

$$\sum_{e \in S_j} y_e = w_j$$

- ▶ Hence our cost is

$$\begin{aligned} \sum_j w_j x_j &= \sum_j \sum_{e \in S_j} y_e = \sum_e |\{j : e \in S_j\}| \cdot y_e \\ &\leq f \cdot \sum_e y_e \leq f \cdot \text{OPT} \end{aligned}$$

Note that the constructed pair of primal and dual solution fulfills **primal slackness conditions**.

This means

$$x_j > 0 \Rightarrow \sum_{e \in S_j} y_e = w_j$$

If we would also fulfill **dual slackness conditions**

$$y_e > 0 \Rightarrow \sum_{j: e \in S_j} x_j = 1$$

then the solution would be **optimal!!!**

We don't fulfill these constraint but we fulfill an approximate version:

$$y_e > 0 \Rightarrow 1 \leq \sum_{j:e \in S_j} x_j \leq f$$

This is sufficient to show that the solution is an f -approximation.

Suppose we have a primal/dual pair

$\begin{aligned} \min \quad & \sum_j c_j x_j \\ \text{s.t.} \quad & \forall i \quad \sum_j a_{ij} x_j \geq b_i \\ & \forall j \quad x_j \geq 0 \end{aligned}$	$\begin{aligned} \max \quad & \sum_i b_i y_i \\ \text{s.t.} \quad & \forall j \quad \sum_i a_{ij} y_i \leq c_j \\ & \forall i \quad y_i \geq 0 \end{aligned}$
---	---

and solutions that fulfill approximate slackness conditions:

$$x_j > 0 \Rightarrow \sum_i a_{ij} y_i \geq \frac{1}{\alpha} c_j$$

$$y_i > 0 \Rightarrow \sum_j a_{ij} x_j \leq \beta b_i$$

Then

right hand side of j -th dual constraint

$$\sum_j c_j x_j \leq \alpha \sum_j \left(\sum_i a_{ij} y_i \right) x_j$$

primal cost

$$= \alpha \sum_i \left(\sum_j a_{ij} x_j \right) y_i$$

$$\leq \alpha \beta \cdot \sum_i b_i y_i$$

dual objective

Feedback Vertex Set for Undirected Graphs

- ▶ Given a graph $G = (V, E)$ and non-negative weights $w_v \geq 0$ for vertex $v \in V$.
- ▶ Choose a minimum cost subset of vertices s.t. every cycle contains at least one vertex.

We can encode this as an instance of Set Cover

- ▶ Each vertex can be viewed as a set that contains some cycles.
- ▶ However, this encoding gives a Set Cover instance of non-polynomial size.
- ▶ The $O(\log n)$ -approximation for Set Cover does not help us to get a good solution.

Let \mathcal{C} denote the set of all cycles (where a cycle is identified by its set of vertices)

Primal Relaxation:

$$\begin{array}{ll} \min & \sum_v w_v x_v \\ \text{s.t.} & \forall C \in \mathcal{C} \quad \sum_{v \in C} x_v \geq 1 \\ & \forall v \quad x_v \geq 0 \end{array}$$

Dual Formulation:

$$\begin{array}{ll} \max & \sum_{C \in \mathcal{C}} y_C \\ \text{s.t.} & \forall v \in V \quad \sum_{C: v \in C} y_C \leq w_v \\ & \forall C \quad y_C \geq 0 \end{array}$$

If we perform the previous dual technique for Set Cover we get the following:

- ▶ Start with $x = 0$ and $y = 0$
- ▶ While there is a cycle C that is not covered (does not contain a chosen vertex).
 - ▶ Increase y_C until dual constraint for some vertex v becomes tight.
 - ▶ set $x_v = 1$.

Then

$$\begin{aligned} \sum_v w_v x_v &= \sum_v \sum_{C: v \in C} y_C x_v \\ &= \sum_{v \in S} \sum_{C: v \in C} y_C \\ &= \sum_C |S \cap C| \cdot y_C \end{aligned}$$

where S is the set of vertices we choose.

If every cycle is short we get a good approximation ratio, but this is unrealistic.

Algorithm 1 FeedbackVertexSet

```
1:  $y \leftarrow 0$ 
2:  $x \leftarrow 0$ 
3: while exists cycle  $C$  in  $G$  do
4:   increase  $y_C$  until there is  $v \in C$  s.t.  $\sum_{C:v \in C} y_C = w_v$ 
5:    $x_v = 1$ 
6:   remove  $v$  from  $G$ 
7:   repeatedly remove vertices of degree 1 from  $G$ 
```

Idea:

Always choose a short cycle that is not covered. If we always find a cycle of length at most α we get an α -approximation.

Observation:

For any path P of vertices of degree 2 in G the algorithm chooses at most one vertex from P .

Observation:

If we always choose a cycle for which the number of vertices of degree at least 3 is at most α we get a 2α -approximation.

Theorem 97

In any graph with no vertices of degree 1, there always exists a cycle that has at most $\mathcal{O}(\log n)$ vertices of degree 3 or more. We can find such a cycle in linear time.

This means we have

$$y_C > 0 \Rightarrow |S \cap C| \leq \mathcal{O}(\log n) .$$

Primal Dual for Shortest Path

Given a graph $G = (V, E)$ with two nodes $s, t \in V$ and edge-weights $c : E \rightarrow \mathbb{R}^+$ find a shortest path between s and t w.r.t. edge-weights c .

$$\begin{array}{ll} \min & \sum_e c(e)x_e \\ \text{s.t.} & \forall S \in \mathcal{S} \quad \sum_{e: \delta(S)} x_e \geq 1 \\ & \forall e \in E \quad x_e \in \{0, 1\} \end{array}$$

Here $\delta(S)$ denotes the set of edges with exactly one end-point in S , and $\mathcal{S} = \{S \subseteq V : s \in S, t \notin S\}$.

Primal Dual for Shortest Path

The Dual:

$$\begin{array}{ll} \max & \sum_S \gamma_S \\ \text{s.t.} & \forall e \in E \quad \sum_{S: e \in \delta(S)} \gamma_S \leq c(e) \\ & \forall S \in \mathcal{S} \quad \gamma_S \geq 0 \end{array}$$

Here $\delta(S)$ denotes the set of edges with exactly one end-point in S , and $\mathcal{S} = \{S \subseteq V : s \in S, t \notin S\}$.

Primal Dual for Shortest Path

We can interpret the value γ_S as the width of a moat surrounding the set S .

Each set can have its own moat but all moats must be disjoint.

An edge cannot be shorter than all the moats that it has to cross.

Algorithm 1 PrimalDualShortestPath

```
1:  $\gamma \leftarrow 0$ 
2:  $F \leftarrow \emptyset$ 
3: while there is no  $s$ - $t$  path in  $(V, F)$  do
4:   Let  $C$  be the connected component of  $(V, F)$  containing  $s$ 
5:   Increase  $\gamma_C$  until there is an edge  $e' \in \delta(C)$  such that  $\sum_{S: e' \in \delta(S)} \gamma_S = c(e')$ .
6:    $F \leftarrow F \cup \{e'\}$ 
7: Let  $P$  be an  $s$ - $t$  path in  $(V, F)$ 
8: return  $P$ 
```

Lemma 98

At each point in time the set F forms a tree.

Proof:

- ▶ In each iteration we take the current connected component from (V, F) that contains s (call this component C) and add some edge from $\delta(C)$ to F .
- ▶ Since, at most one end-point of the new edge is in C the edge cannot close a cycle.

$$\begin{aligned} \sum_{e \in P} c(e) &= \sum_{e \in P} \sum_{S: e \in \delta(S)} y_S \\ &= \sum_{S: s \in S, t \notin S} |P \cap \delta(S)| \cdot y_S. \end{aligned}$$

If we can show that $y_S > 0$ implies $|P \cap \delta(S)| = 1$ gives

$$\sum_{e \in P} c(e) = \sum_S y_S \leq \text{OPT}$$

by weak duality.

Hence, we find a shortest path.

If S contains two edges from P then there must exist a subpath P' of P that starts and ends with a vertex from S (and all interior vertices are not in S).

When we increased y_S , S was a connected component of the set of edges F' that we had chosen till this point.

$F' \cup P'$ contains a cycle. Hence, also the final set of edges contains a cycle.

This is a contradiction.

Steiner Forest Problem:

Given a graph $G = (V, E)$, together with source-target pairs s_i, t_i , $i = 1, \dots, k$, and a cost function $c: E \rightarrow \mathbb{R}^+$ on the edges. Find a subset $F \subseteq E$ of the edges such that for every $i \in \{1, \dots, k\}$ there is a path between s_i and t_i only using edges in F .

$$\begin{array}{ll} \min & \sum_e c(e) x_e \\ \text{s.t.} & \forall S \subseteq V: S \in S_i \text{ for some } i \quad \sum_{e \in \delta(S)} x_e \geq 1 \\ & \forall e \in E \quad x_e \in \{0, 1\} \end{array}$$

Here S_i contains all sets S such that $s_i \in S$ and $t_i \notin S$.

$$\begin{array}{ll} \max & \sum_{S: \exists i \text{ s.t. } S \in S_i} y_S \\ \text{s.t.} & \forall e \in E \quad \sum_{S: e \in \delta(S)} y_S \leq c(e) \\ & y_S \geq 0 \end{array}$$

The difference to the dual of the shortest path problem is that we have many more variables (sets for which we can generate a moat of non-zero width).

Algorithm 1 FirstTry

```
1:  $\gamma \leftarrow 0$ 
2:  $F \leftarrow \emptyset$ 
3: while not all  $s_i$ - $t_i$  pairs connected in  $F$  do
4:   Let  $C$  be some connected component of  $(V, F)$ 
     such that  $|C \cap \{s_i, t_i\}| = 1$  for some  $i$ .
5:   Increase  $\gamma_C$  until there is an edge  $e' \in \delta(C)$  s.t.
      $\sum_{S \in \mathcal{S}; e' \in \delta(S)} \gamma_S = c_{e'}$ 
6:    $F \leftarrow F \cup \{e'\}$ 
7: return  $\bigcup_i P_i$ 
```

$$\sum_{e \in F} c(e) = \sum_{e \in F} \sum_{S: e \in \delta(S)} \gamma_S = \sum_S |\delta(S) \cap F| \cdot \gamma_S.$$

If we show that $\gamma_S > 0$ implies that $|\delta(S) \cap F| \leq \alpha$ we are in good shape.

However, this is not true:

- ▶ Take a complete graph on $k + 1$ vertices v_0, v_1, \dots, v_k .
- ▶ The i -th pair is v_0 - v_i .
- ▶ The first component C could be $\{v_0\}$.
- ▶ We only set $\gamma_{\{v_0\}} = 1$. All other dual variables stay 0.
- ▶ The final set F contains all edges $\{v_0, v_i\}$, $i = 1, \dots, k$.
- ▶ $\gamma_{\{v_0\}} > 0$ but $|\delta(\{v_0\}) \cap F| = k$.

Algorithm 1 SecondTry

```
1:  $\gamma \leftarrow 0$ ;  $F \leftarrow \emptyset$ ;  $\ell \leftarrow 0$ 
2: while not all  $s_i$ - $t_i$  pairs connected in  $F$  do
3:    $\ell \leftarrow \ell + 1$ 
4:   Let  $\mathcal{C}$  be set of all connected components  $C$  of  $(V, F)$ 
     such that  $|C \cap \{s_i, t_i\}| = 1$  for some  $i$ .
5:   Increase  $\gamma_C$  for all  $C \in \mathcal{C}$  uniformly until for some edge
      $e_\ell \in \delta(C')$ ,  $C' \in \mathcal{C}$  s.t.  $\sum_{S: e_\ell \in \delta(S)} \gamma_S = c_{e_\ell}$ 
6:    $F \leftarrow F \cup \{e_\ell\}$ 
7:  $F' \leftarrow F$ 
8: for  $k \leftarrow \ell$  downto 1 do // reverse deletion
9:   if  $F' - e_k$  is feasible solution then
10:     remove  $e_k$  from  $F'$ 
11: return  $F'$ 
```

The reverse deletion step is not strictly necessary this way. It would also be sufficient to simply delete all unnecessary edges in any order.

Example

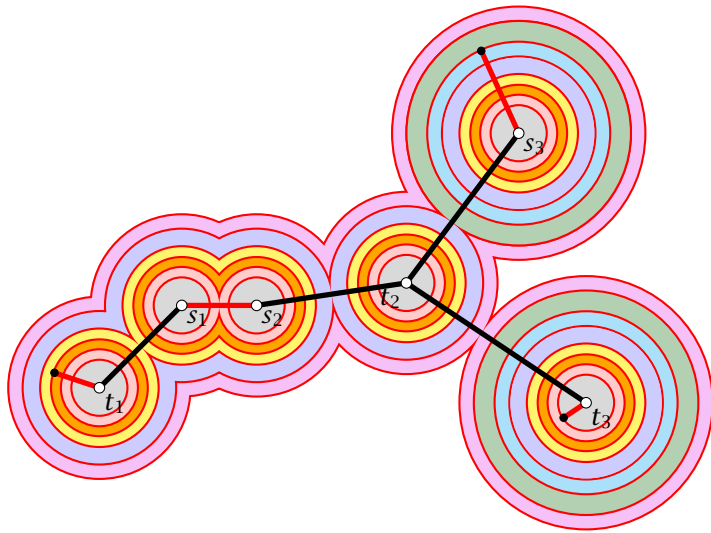

Lemma 99

For any \mathcal{C} in any iteration of the algorithm

$$\sum_{C \in \mathcal{C}} |\delta(C) \cap F'| \leq 2|\mathcal{C}|$$

This means that the number of times a moat from \mathcal{C} is crossed in the final solution is at most twice the number of moats.

Proof: later...

$$\sum_{e \in F'} c_e = \sum_{e \in F'} \sum_{S: e \in \delta(S)} \gamma_S = \sum_S |F' \cap \delta(S)| \cdot \gamma_S.$$

We want to show that

$$\sum_S |F' \cap \delta(S)| \cdot \gamma_S \leq 2 \sum_S \gamma_S$$

- ▶ In the i -th iteration the increase of the left-hand side is

$$\epsilon \sum_{C \in \mathcal{C}} |F' \cap \delta(C)|$$

and the increase of the right hand side is $2\epsilon|\mathcal{C}|$.

- ▶ Hence, by the previous lemma the inequality holds after the iteration if it holds in the beginning of the iteration.

Lemma 100

For any set of connected components \mathcal{C} in any iteration of the algorithm

$$\sum_{C \in \mathcal{C}} |\delta(C) \cap F'| \leq 2|\mathcal{C}|$$

Proof:

- ▶ At any point during the algorithm the set of edges forms a forest (why?).
- ▶ Fix iteration i . Let F_i be the set of edges in F at the beginning of the iteration.
- ▶ Let $H = F' - F_i$.
- ▶ All edges in H are necessary for the solution.

- ▶ Contract all edges in F_i into single vertices V' .
- ▶ We can consider the forest H on the set of vertices V' .
- ▶ Let $\deg(v)$ be the degree of a vertex $v \in V'$ within this forest.
- ▶ Color a vertex $v \in V'$ **red** if it corresponds to a component from \mathcal{C} (an active component). Otw. color it blue. (Let B the set of blue vertices (with non-zero degree) and R the set of red vertices)
- ▶ We have

$$\sum_{v \in R} \deg(v) \geq \sum_{C \in \mathcal{C}} |\delta(C) \cap F'| \stackrel{?}{\leq} 2|\mathcal{C}| = 2|R|$$

- ▶ Suppose that no node in B has degree one.
- ▶ Then

$$\begin{aligned} \sum_{v \in R} \deg(v) &= \sum_{v \in R \cup B} \deg(v) - \sum_{v \in B} \deg(v) \\ &\leq 2(|R| + |B|) - 2|B| = 2|R| \end{aligned}$$

- ▶ Every blue vertex with non-zero degree must have degree at least two.
 - ▶ Suppose not. The single edge connecting $b \in B$ comes from H , and, hence, is necessary.
 - ▶ But this means that the cluster corresponding to b must separate a source-target pair.
 - ▶ But then it must be a red node.

18 Cuts & Metrics

Shortest Path

$$\begin{aligned} \min \quad & \sum_e c(e)x_e \\ \text{s.t.} \quad & \forall S \in \mathcal{S} \quad \sum_{e \in \delta(S)} x_e \geq 1 \\ & \forall e \in E \quad x_e \in \{0, 1\} \end{aligned}$$

\mathcal{S} is the set of subsets that separate s from t .

The Dual:

$$\begin{aligned} \max \quad & \sum_S y_S \\ \text{s.t.} \quad & \forall e \in E \quad \sum_{S: e \in \delta(S)} y_S \leq c(e) \\ & \forall S \in \mathcal{S} \quad y_S \geq 0 \end{aligned}$$

The **Separation Problem** for the Shortest Path LP is the Minimum Cut Problem.

18 Cuts & Metrics

Minimum Cut

$$\begin{aligned} \min \quad & \sum_e c(e)x_e \\ \text{s.t.} \quad & \forall P \in \mathcal{P} \quad \sum_{e \in P} x_e \geq 1 \\ & \forall e \in E \quad x_e \in \{0, 1\} \end{aligned}$$

\mathcal{P} is the set of path that connect s and t .

The Dual:

$$\begin{aligned} \max \quad & \sum_P y_P \\ \text{s.t.} \quad & \forall e \in E \quad \sum_{P: e \in P} y_P \leq c(e) \\ & \forall P \in \mathcal{P} \quad y_P \geq 0 \end{aligned}$$

The **Separation Problem** for the Minimum Cut LP is the Shortest Path Problem.

18 Cuts & Metrics

Observations:

Suppose that ℓ_e -values are solution to Minimum Cut LP.

- ▶ We can view ℓ_e as defining the **length** of an edge.
- ▶ Define $d(u, v) = \min_{\text{path } P \text{ btw. } u \text{ and } v} \sum_{e \in P} \ell_e$ as the **Shortest Path Metric** induced by ℓ_e .
- ▶ We have $d(u, v) = \ell_e$ for every edge $e = (u, v)$, as otw. we could reduce ℓ_e without affecting the distance between s and t .

Remark for bean-counters:

d is not a metric on V but a semimetric as two nodes u and v could have distance zero.

How do we round the LP?

- ▶ Let $B(s, r)$ be the ball of radius r around s (w.r.t. metric d).
Formally:

$$B = \{v \in V \mid d(s, v) \leq r\}$$

- ▶ For $0 \leq r < 1$, $B(s, r)$ is an s - t -cut.

Which value of r should we choose? **choose randomly!!!**

Formally:

choose r u.a.r. (uniformly at random) from interval $[0, 1)$

What is the probability that an edge (u, v) is in the cut?

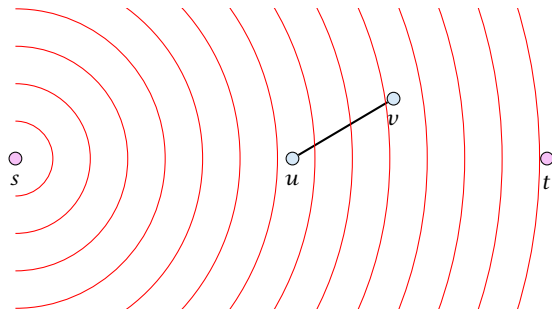

- ▶ assume wlog. $d(s, u) \leq d(s, v)$

$$\Pr[e \text{ is cut}] = \Pr[r \in [d(s, u), d(s, v)]] \leq \frac{d(s, v) - d(s, u)}{1 - 0} \leq \ell_e$$

What is the expected size of a cut?

$$\begin{aligned} \mathbb{E}[\text{size of cut}] &= \mathbb{E}\left[\sum_e c(e) \Pr[e \text{ is cut}]\right] \\ &\leq \sum_e c(e) \ell_e \end{aligned}$$

On the other hand:

$$\sum_e c(e) \ell_e \leq \text{size of mincut}$$

as the ℓ_e are the solution to the Mincut LP relaxation.

Hence, our rounding gives an optimal solution.

Minimum Multicut:

Given a graph $G = (V, E)$, together with source-target pairs s_i, t_i , $i = 1, \dots, k$, and a capacity function $c : E \rightarrow \mathbb{R}^+$ on the edges. Find a subset $F \subseteq E$ of the edges such that all s_i-t_i pairs lie in different components in $G = (V, E \setminus F)$.

$$\begin{array}{ll} \min & \sum_e c(e) \ell_e \\ \text{s.t.} & \forall P \in \mathcal{P}_i \text{ for some } i \quad \sum_{e \in P} \ell_e \geq 1 \\ & \forall e \in E \quad \ell_e \in \{0, 1\} \end{array}$$

Here \mathcal{P}_i contains all path P between s_i and t_i .

Re-using the analysis for the single-commodity case is difficult.

$$\Pr[e \text{ is cut}] \leq ?$$

- ▶ If for some R the balls $B(s_i, R)$ are disjoint between different sources, we get a $1/R$ approximation.
- ▶ However, this cannot be guaranteed.

- ▶ Assume for simplicity that all edge-length ℓ_e are multiples of $\delta \ll 1$.
- ▶ Replace the graph G by a graph G' , where an edge of length ℓ_e is replaced by ℓ_e/δ edges of length δ .
- ▶ Let $B(s_i, z)$ be the ball in G' that contains nodes v with distance $d(s_i, v) \leq z\delta$.

Algorithm 1 RegionGrowing(s_i, p)

```
1:  $z \leftarrow 0$ 
2: repeat
3:   flip a coin ( $\Pr[\text{heads}] = p$ )
4:    $z \leftarrow z + 1$ 
5: until heads
6: return  $B(s_i, z)$ 
```

Algorithm 1 Multicut(G')

```
1: while  $\exists s_i-t_i$  pair in  $G'$  do
2:    $C \leftarrow \text{RegionGrowing}(s_i, p)$ 
3:    $G' = G' \setminus C$  // cuts edges leaving  $C$ 
4: return  $B(s_i, z)$ 
```

- ▶ probability of cutting an edge is only p
- ▶ a source either does not reach an edge during Region Growing; then it is not cut
- ▶ if it reaches the edge then it either **cuts** the edge or **protects** the edge from being cut by other sources
- ▶ if we choose $p = \delta$ the probability of cutting an edge is only its LP-value; our expected cost are at most **OPT**.

Problem:

We may not cut all source-target pairs.

A component that we remove may contain an s_i-t_i pair.

If we ensure that we cut before reaching radius $1/2$ we are in good shape.

- ▶ choose $p = 6 \ln k \cdot \delta$
- ▶ we make $\frac{1}{2\delta}$ trials before reaching radius $1/2$.
- ▶ we say a Region Growing is not successful if it does not terminate before reaching radius $1/2$.

$$\Pr[\text{not successful}] \leq (1-p)^{\frac{1}{2\delta}} = \left((1-p)^{1/p} \right)^{\frac{p}{2\delta}} \leq e^{-\frac{p}{2\delta}} \leq \frac{1}{k^3}$$

- ▶ Hence,

$$\Pr[\exists i \text{ that is not successful}] \leq \frac{1}{k^2}$$

What is expected cost?

$$\begin{aligned} E[\text{cutsizes}] &= \Pr[\text{success}] \cdot E[\text{cutsizes} \mid \text{success}] \\ &\quad + \Pr[\text{no success}] \cdot E[\text{cutsizes} \mid \text{no success}] \end{aligned}$$

$$\begin{aligned} E[\text{cutsizes} \mid \text{succ.}] &= \frac{E[\text{cutsizes}] - \Pr[\text{no succ.}] \cdot E[\text{cutsizes} \mid \text{no succ.}]}{\Pr[\text{success}]} \\ &\leq \frac{E[\text{cutsizes}]}{\Pr[\text{success}]} \leq \frac{1}{1 - \frac{1}{k^2}} 6 \ln k \cdot \text{OPT} \leq 8 \ln k \cdot \text{OPT} \end{aligned}$$

Note: **success** means all source-target pairs separated

We assume $k \geq 2$.

If we are not successful we simply perform a trivial k -approximation.

This only increases the expected cost by at most $\frac{1}{k^2} \cdot k \text{OPT} \leq \text{OPT}/k$.

Hence, our final cost is $\mathcal{O}(\ln k) \cdot \text{OPT}$ in expectation.

Gap Introducing Reduction

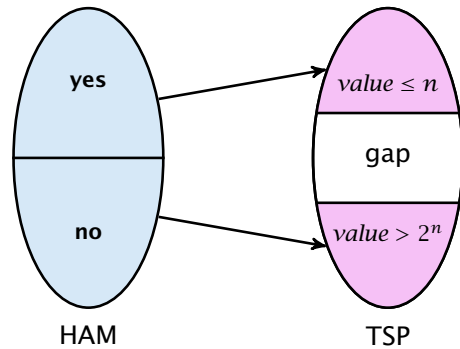

Reduction from Hamiltonian cycle to TSP

- ▶ instance that has Hamiltonian cycle is mapped to TSP instance with small cost
- ▶ otherwise it is mapped to instance with large cost
- ▶ \Rightarrow there is no $2^n/n$ -approximation for TSP

PCP theorem: Approximation View

Theorem 101 (PCP Theorem A)

There exists $\epsilon > 0$ for which there is gap introducing reduction between 3SAT and MAX3SAT.

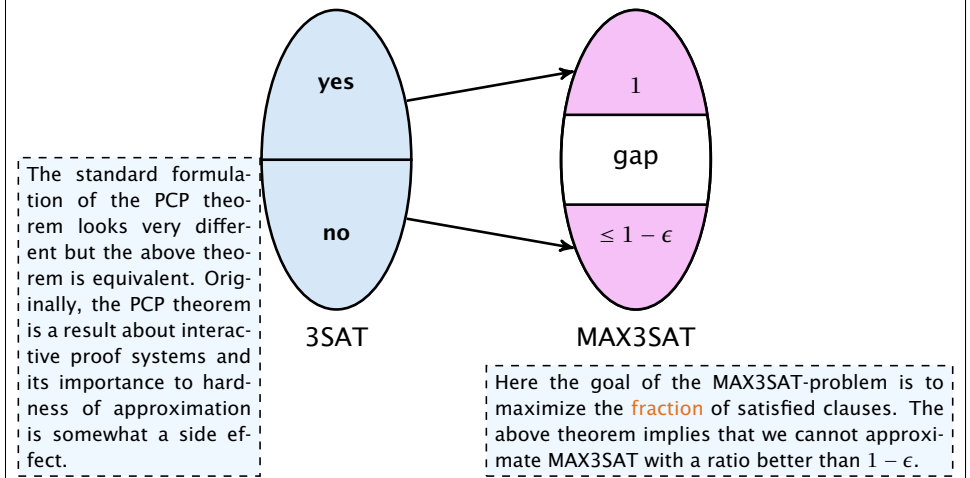

PCP theorem: Proof System View

Definition 102 (NP)

A language $L \in \text{NP}$ if there exists a polynomial time, deterministic verifier V (a Turing machine), s.t.

$[x \in L]$ completeness

There exists a proof string y , $|y| = \text{poly}(|x|)$, s.t. $V(x, y) = \text{"accept"}$.

$[x \notin L]$ soundness

For any proof string y , $V(x, y) = \text{"reject"}$.

Note that requiring $|y| = \text{poly}(|x|)$ for $x \notin L$ does not make a difference (why?).

Probabilistic Checkable Proofs

An Oracle Turing Machine M is a Turing machine that has access to an oracle.

Such an oracle allows M to solve some problem in a single step.

For example having access to a TSP-oracle π_{TSP} would allow M to write a TSP-instance x on a special oracle tape and obtain the answer (yes or no) in a single step.

For such TMs one looks in addition to running time also at query complexity, i.e., how often the machine queries the oracle.

For a proof string y , π_y is an oracle that upon given an index i returns the i -th character y_i of y .

Probabilistic Checkable Proofs

Non-adaptive means that e.g. the second proof-bit read by the verifier may not depend on the value of the first bit.

Definition 103 (PCP)

A language $L \in \text{PCP}_{c(n),s(n)}(r(n),q(n))$ if there exists a polynomial time, non-adaptive, randomized verifier V , s.t.

$[x \in L]$ There exists a proof string y , s.t. $V^{\pi y}(x) = \text{“accept”}$ with probability $\geq c(n)$.

$[x \notin L]$ For any proof string y , $V^{\pi y}(x) = \text{“accept”}$ with probability $\leq s(n)$.

The verifier uses at most $\mathcal{O}(r(n))$ random bits and makes at most $\mathcal{O}(q(n))$ oracle queries.

Note that the proof itself does not count towards the input of the verifier. The verifier has to write the number of a bit-position it wants to read onto a special tape, and then the corresponding bit from the proof is returned to the verifier. The proof may only be exponentially long, as a polynomial time verifier cannot address longer proofs.

Probabilistic Checkable Proofs

$c(n)$ is called the **completeness**. If not specified otw. $c(n) = 1$.
Probability of accepting a correct proof.

$s(n) < c(n)$ is called the **soundness**. If not specified otw. $s(n) = 1/2$.
Probability of accepting a wrong proof.

$r(n)$ is called the **randomness complexity**, i.e., how many random bits the (randomized) verifier uses.

$q(n)$ is the **query complexity** of the verifier.

Probabilistic Checkable Proofs

RP = coRP = P is a commonly believed conjecture. RP stands for randomized polynomial time (with a non-zero probability of rejecting a YES-instance).

- ▶ $P = \text{PCP}(0, 0)$
verifier without randomness and proof access is deterministic algorithm
- ▶ $\text{PCP}(\log n, 0) \subseteq P$
we can simulate $\mathcal{O}(\log n)$ random bits in deterministic, polynomial time
- ▶ $\text{PCP}(0, \log n) \subseteq P$
we can simulate short proofs in polynomial time
- ▶ $\text{PCP}(\text{poly}(n), 0) = \text{coRP} \stackrel{?!}{=} P$
by definition; coRP is randomized polytime with one sided error (positive probability of accepting NO-instance)

Note that the first three statements also hold with equality

Probabilistic Checkable Proofs

- ▶ $\text{PCP}(0, \text{poly}(n)) = \text{NP}$
by definition; NP-verifier does not use randomness and asks polynomially many queries
- ▶ $\text{PCP}(\log n, \text{poly}(n)) \subseteq \text{NP}$
NP-verifier can simulate $\mathcal{O}(\log n)$ random bits
- ▶ $\text{PCP}(\text{poly}(n), 0) = \text{coRP} \stackrel{?!}{=} \text{NP}$
- ▶ $\text{NP} \subseteq \text{PCP}(\log n, 1)$
hard part of the PCP-theorem

PCP theorem: Proof System View

Theorem 104 (PCP Theorem B)

$\text{NP} = \text{PCP}(\log n, 1)$

Probabilistic Proof for Graph Nonisomorphism

GNI is the language of pairs of non-isomorphic graphs

Verifier gets input (G_0, G_1) (two graphs with n -nodes)

It expects a proof of the following form:

- ▶ For any **labeled** n -node graph H the H 's bit $P[H]$ of the proof fulfills

$$G_0 \equiv H \Rightarrow P[H] = 0$$

$$G_1 \equiv H \Rightarrow P[H] = 1$$

$$G_0, G_1 \not\equiv H \Rightarrow P[H] = \text{arbitrary}$$

Probabilistic Proof for Graph Nonisomorphism

Verifier:

- ▶ choose $b \in \{0, 1\}$ at random
- ▶ take graph G_b and apply a random permutation to obtain a labeled graph H
- ▶ check whether $P[H] = b$

If $G_0 \not\equiv G_1$ then by using the obvious proof the verifier will always accept.

If $G_0 \equiv G_1$ a proof only accepts with probability $1/2$.

- ▶ suppose $\pi(G_0) = G_1$
- ▶ if we accept for $b = 1$ and permutation π_{rand} we reject for $b = 0$ and permutation $\pi_{\text{rand}} \circ \pi$

Version B \Rightarrow Version A

- ▶ For 3SAT there exists a verifier that uses $c \log n$ random bits, reads $q = \mathcal{O}(1)$ bits from the proof, has completeness 1 and soundness $1/2$.
- ▶ fix x and r :

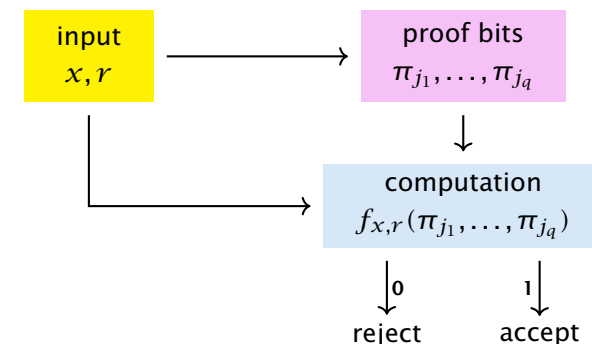

Version B \Rightarrow Version A

- ▶ transform Boolean formula $f_{x,r}$ into 3SAT formula $C_{x,r}$ (constant size, variables are proof bits)
- ▶ consider 3SAT formula $C_x := \bigwedge_r C_{x,r}$

$[x \in L]$ There exists proof string y , s.t. all formulas $C_{x,r}$ evaluate to 1. Hence, all clauses in C_x satisfied.

$[x \notin L]$ For any proof string y , at most 50% of formulas $C_{x,r}$ evaluate to 1. Since each contains only a constant number of clauses, a constant fraction of clauses in C_x are not satisfied.

- ▶ this means we have gap introducing reduction

Version A \Rightarrow Version B

We show: Version A \Rightarrow $\text{NP} \subseteq \text{PCP}_{1,1-\epsilon}(\log n, 1)$.

given $L \in \text{NP}$ we build a PCP-verifier for L

Verifier:

- ▶ 3SAT is NP-complete; map instance x for L into 3SAT instance I_x , s.t. I_x satisfiable iff $x \in L$
- ▶ map I_x to MAX3SAT instance C_x (PCP Thm. Version A)
- ▶ interpret proof as assignment to variables in C_x
- ▶ choose random clause X from C_x
- ▶ query variable assignment σ for X ;
- ▶ accept if $X(\sigma) = \text{true}$ otw. reject

Version A \Rightarrow Version B

$[x \in L]$ There exists proof string y , s.t. all clauses in C_x evaluate to 1. In this case the verifier returns 1.

$[x \notin L]$ For any proof string y , at most a $(1-\epsilon)$ -fraction of clauses in C_x evaluate to 1. The verifier will reject with probability at least ϵ .

To show Theorem B we only need to run this verifier a constant number of times to push rejection probability above $1/2$.

$\text{NP} \subseteq \text{PCP}(\text{poly}(n), 1)$

Note that this approach has strong connections to error correction codes.

$\text{PCP}(\text{poly}(n), 1)$ means we have a potentially exponentially long proof but we only read a constant number of bits from it.

The idea is to encode an NP-witness (e.g. a satisfying assignment (say n bits)) by a code whose code-words have 2^n bits.

A wrong proof is either

- ▶ a code-word whose pre-image does not correspond to a satisfying assignment
- ▶ or, a sequence of bits that does not correspond to a code-word

We can detect both cases by querying a few positions.

The Code

$u \in \{0, 1\}^n$ (satisfying assignment)

Walsh-Hadamard Code:

$WH_u : \{0, 1\}^n \rightarrow \{0, 1\}, x \mapsto x^T u$ (over $GF(2)$)

The code-word for u is WH_u . We identify this function by a bit-vector of length 2^n .

The Code

Lemma 105

If $u \neq u'$ then WH_u and $WH_{u'}$ differ in at least 2^{n-1} bits.

Proof:

Suppose that $u - u' \neq 0$. Then

$$WH_u(x) \neq WH_{u'}(x) \iff (u - u')^T x \neq 0$$

This holds for 2^{n-1} different vectors x .

The Code

Suppose we are given access to a function $f : \{0, 1\}^n \rightarrow \{0, 1\}$ and want to check whether it is a codeword.

Since the set of codewords is the set of all linear functions $\{0, 1\}^n$ to $\{0, 1\}$ we can check

$$f(x + y) = f(x) + f(y)$$

for all 2^{2n} pairs x, y . **But that's not very efficient.**

$NP \subseteq PCP(\text{poly}(n), 1)$

Can we just check a constant number of positions?

NP \subseteq PCP(poly(n), 1)

Observe that for two codewords
 $\Pr_{x \in \{0,1\}^n} [f(x) = g(x)] = 1/2$.

Definition 106

Let $\rho \in [0, 1]$. We say that $f, g : \{0, 1\}^n \rightarrow \{0, 1\}$ are ρ -close if

$$\Pr_{x \in \{0,1\}^n} [f(x) = g(x)] \geq \rho .$$

Theorem 107 (proof deferred)

Let $f : \{0, 1\}^n \rightarrow \{0, 1\}$ with

$$\Pr_{x, y \in \{0,1\}^n} [f(x) + f(y) = f(x + y)] \geq \rho > \frac{1}{2} .$$

Then there is a linear function \tilde{f} such that f and \tilde{f} are ρ -close.

NP \subseteq PCP(poly(n), 1)

We need $\mathcal{O}(1/\delta)$ trials to be sure that f is $(1 - \delta)$ -close to a linear function with (arbitrary) constant probability.

NP \subseteq PCP(poly(n), 1)

Suppose for $\delta < 1/4$ f is $(1 - \delta)$ -close to some linear function \tilde{f} .

\tilde{f} is uniquely defined by f , since linear functions differ on at least half their inputs.

Suppose we are given $x \in \{0, 1\}^n$ and access to f . Can we compute $\tilde{f}(x)$ using only constant number of queries?

NP \subseteq PCP(poly(n), 1)

Suppose we are given $x \in \{0, 1\}^n$ and access to f . Can we compute $\tilde{f}(x)$ using only constant number of queries?

1. Choose $x' \in \{0, 1\}^n$ u.a.r.
2. Set $x'' := x + x'$.
3. Let $y' = f(x')$ and $y'' = f(x'')$.
4. Output $y' + y''$.

x' and x'' are uniformly distributed (albeit dependent). With probability at least $1 - 2\delta$ we have $f(x') = \tilde{f}(x')$ and $f(x'') = \tilde{f}(x'')$.

Then the above routine returns $\tilde{f}(x)$.

This technique is known as local decoding of the Walsh-Hadamard code.

NP \subseteq PCP(poly(n), 1)

We show that $\text{QUADEQ} \in \text{PCP}(\text{poly}(n), 1)$. The theorem follows since any PCP-class is closed under polynomial time reductions.

QUADEQ

Given a system of quadratic equations over $\text{GF}(2)$. Is there a solution?

QUADEQ is NP-complete

- ▶ given 3SAT instance C represent it as Boolean circuit
e.g. $C = (x_1 \vee x_2 \vee x_3) \wedge (x_3 \vee x_4 \vee \bar{x}_5) \wedge (x_6 \vee x_7 \vee x_8)$
- ▶ add variable for every wire
- ▶ add constraint for every gate
OR: $i_1 + i_2 + i_1 \cdot i_2 = 0$
AND: $i_1 \cdot i_2 = 0$
NEG: $i = 1 - o$
- ▶ add constraint $out = 1$
- ▶ system is feasible iff C is satisfiable

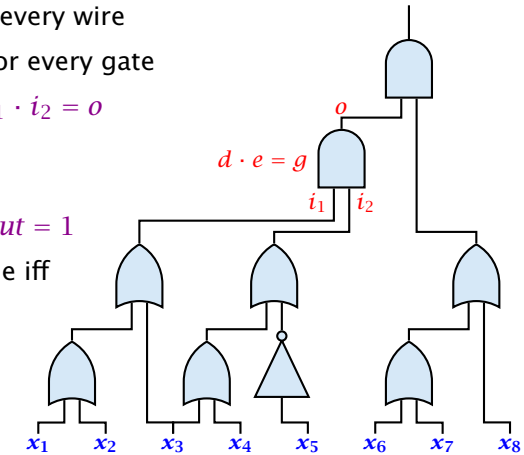

NP \subseteq PCP(poly(n), 1)

Note that over $\text{GF}(2)$ $x = x^2$. Therefore, we can assume that there are no terms of degree 1.

We encode an instance of QUADEQ by a matrix A that has n^2 columns; one for every pair i, j ; and a right hand side vector b .

For an n -dimensional vector x we use $x \otimes x$ to denote the n^2 -dimensional vector whose i, j -th entry is $x_i x_j$.

Then we are asked whether

$$A(x \otimes x) = b$$

has a solution.

NP \subseteq PCP(poly(n), 1)

Let A, b be an instance of QUADEQ . Let u be a satisfying assignment.

The correct PCP-proof will be the Walsh-Hadamard encodings of u and $u \otimes u$. The verifier will accept such a proof with probability 1.

We have to make sure that we reject proofs that do not correspond to codewords for vectors of the form u , and $u \otimes u$.

We also have to reject proofs that correspond to codewords for vectors of the form z , and $z \otimes z$, where z is not a satisfying assignment.

NP \subseteq PCP(poly(n), 1)

Recall that for a correct proof there is no difference between f and \tilde{f} .

Step 1. Linearity Test.

The proof contains $2^n + 2^{n^2}$ bits. This is interpreted as a pair of functions $f : \{0, 1\}^n \rightarrow \{0, 1\}$ and $g : \{0, 1\}^{n^2} \rightarrow \{0, 1\}$.

We do a 0.999-linearity test for both functions (requires a constant number of queries).

We also assume that for the remaining constant number of accesses WH-decoding succeeds and we recover $\tilde{f}(x)$.

Hence, our proof will only ever see \tilde{f} . To simplify notation we use f for \tilde{f} , in the following (similar for g, \tilde{g}).

NP \subseteq PCP(poly(n), 1)

We need to show that the probability of accepting a wrong proof is small.

This first step means that in order to fool us with reasonable probability a wrong proof needs to be very close to a linear function. The probability that we accept a proof when the functions are not close to linear is just a small constant.

Similarly, if the functions are close to linear then the probability that the Walsh Hadamard decoding fails (for *any* of the remaining accesses) is just a small constant. If we ignore this small constant error then a malicious prover could also provide a linear function (as a near-linear function f is “rounded” by us to the corresponding linear function \tilde{f}). If this rounding is successful it doesn’t make sense for the prover to provide a function that is not linear.

NP \subseteq PCP(poly(n), 1)

Step 2. Verify that g encodes $u \otimes u$ where u is string encoded by f .

$f(r) = u^T r$ and $g(z) = w^T z$ since f, g are linear.

- ▶ choose r, r' independently, u.a.r. from $\{0, 1\}^n$
- ▶ if $f(r)f(r') \neq g(r \otimes r')$ reject
- ▶ repeat 3 times

NP \subseteq PCP(poly(n), 1)

A correct proof survives the test

$$\begin{aligned} f(r) \cdot f(r') &= u^T r \cdot u^T r' \\ &= \left(\sum_i u_i r_i \right) \cdot \left(\sum_j u_j r'_j \right) \\ &= \sum_{ij} u_i u_j r_i r'_j \\ &= (u \otimes u)^T (r \otimes r') \\ &= g(r \otimes r') \end{aligned}$$

NP \subseteq PCP(poly(n), 1)

Suppose that the proof is not correct and $w \neq u \otimes u$.

Let W be $n \times n$ -matrix with entries from w . Let U be matrix with $U_{ij} = u_i \cdot u_j$ (entries from $u \otimes u$).

$$g(r \otimes r') = w^T(r \otimes r') = \sum_{ij} w_{ij}r_i r'_j = r^T W r'$$

$$f(r)f(r') = u^T r \cdot u^T r' = r^T U r'$$

If $U \neq W$ then $W r' \neq U r'$ with probability at least 1/2. Then $r^T W r' \neq r^T U r'$ with probability at least 1/4.

For a non-zero vector x and a random vector r (both with elements from GF(2)), we have $\Pr[x^T r \neq 0] = \frac{1}{2}$. This holds because the product is zero iff the number of ones in r that "hit" ones in x in the product is even.

NP \subseteq PCP(poly(n), 1)

Step 3. Verify that f encodes satisfying assignment.

We need to check

$$A_k(u \otimes u) = b_k$$

where A_k is the k -th row of the constraint matrix. But the left hand side is just $g(A_k^T)$.

We can handle this by a single query but checking all constraints would take $\mathcal{O}(m)$ steps.

We compute $r^T A$, where $r \in_R \{0, 1\}^m$. If u is not a satisfying assignment then with probability 1/2 the vector r will hit an odd number of violated constraints.

In this case $r^T A(u \otimes u) \neq r^T b_k$. The left hand side is equal to $g(A^T r)$.

NP \subseteq PCP(poly(n), 1)

We used the following theorem for the linearity test:

Theorem 107

Let $f : \{0, 1\}^n \rightarrow \{0, 1\}$ with

$$\Pr_{x, y \in \{0, 1\}^n} [f(x) + f(y) = f(x + y)] \geq \rho > \frac{1}{2}.$$

Then there is a linear function \tilde{f} such that f and \tilde{f} are ρ -close.

NP \subseteq PCP(poly(n), 1)

Fourier Transform over GF(2)

In the following we use $\{-1, 1\}$ instead of $\{0, 1\}$. We map $b \in \{0, 1\}$ to $(-1)^b$.

This turns summation into multiplication.

The set of function $f : \{-1, 1\}^n \rightarrow \mathbb{R}$ form a 2^n -dimensional Hilbert space.

NP \subseteq PCP(poly(n), 1)

Hilbert space

- ▶ addition $(f + g)(x) = f(x) + g(x)$
- ▶ scalar multiplication $(\alpha f)(x) = \alpha f(x)$
- ▶ inner product $\langle f, g \rangle = E_{x \in \{-1, 1\}^n} [f(x)g(x)]$
(bilinear, $\langle f, f \rangle \geq 0$, and $\langle f, f \rangle = 0 \Rightarrow f = 0$)
- ▶ **completeness**: any sequence x_k of vectors for which

$$\sum_{k=1}^{\infty} \|x_k\| < \infty \text{ fulfills } \left\| L - \sum_{k=1}^N x_k \right\| \rightarrow 0$$

for some vector L .

NP \subseteq PCP(poly(n), 1)

standard basis

$$e_x(y) = \begin{cases} 1 & x = y \\ 0 & \text{otw.} \end{cases}$$

Then, $f(x) = \sum_i \alpha_i e_i(x)$ where $\alpha_x = f(x)$, this means the functions e_i form a basis. This basis is orthonormal.

NP \subseteq PCP(poly(n), 1)

fourier basis

For $\alpha \subseteq [n]$ define

$$\chi_\alpha(x) = \prod_{i \in \alpha} x_i$$

Note that

$$\langle \chi_\alpha, \chi_\beta \rangle = E_x [\chi_\alpha(x) \chi_\beta(x)] = E_x [\chi_{\alpha \Delta \beta}(x)] = \begin{cases} 1 & \alpha = \beta \\ 0 & \text{otw.} \end{cases}$$

This means the χ_α 's also define an orthonormal basis. (since we have 2^n orthonormal vectors...)

NP \subseteq PCP(poly(n), 1)

A function χ_α multiplies a set of x_i 's. Back in the GF(2)-world this means summing a set of z_i 's where $x_i = (-1)^{z_i}$.

This means the function χ_α correspond to linear functions in the GF(2) world.

NP \subseteq PCP(poly(n), 1)

We can write any function $f : \{-1, 1\}^n \rightarrow \mathbb{R}$ as

$$f = \sum_{\alpha} \hat{f}_{\alpha} \chi_{\alpha}$$

We call \hat{f}_{α} the α^{th} Fourier coefficient.

Lemma 108

1. $\langle f, g \rangle = \sum_{\alpha} \hat{f}_{\alpha} \hat{g}_{\alpha}$
2. $\langle f, f \rangle = \sum_{\alpha} \hat{f}_{\alpha}^2$

Note that for Boolean functions $f : \{-1, 1\}^n \rightarrow \{-1, 1\}$,
 $\langle f, f \rangle = 1$.

$$\langle f, f \rangle = E_x[f(x)^2] = 1$$

Linearity Test

in GF(2):

We want to show that if $\Pr_{x,y}[f(x) + f(y) = f(x + y)]$ is large than f has a large agreement with a linear function.

in Hilbert space: (we will prove)

Suppose $f : \{\pm 1\}^n \rightarrow \{-1, 1\}$ fulfills

$$\Pr_{x,y}[f(x)f(y) = f(x \circ y)] \geq \frac{1}{2} + \epsilon .$$

Then there is some $\alpha \subseteq [n]$, s.t. $\hat{f}_{\alpha} \geq 2\epsilon$.

Here $x \circ y$ denotes the n -dimensional vector with entry $x_i y_i$ in position i (Hadamard product).
Observe that we have $\chi_{\alpha}(x \circ y) = \chi_{\alpha}(x) \chi_{\alpha}(y)$.

Linearity Test

For Boolean functions $\langle f, g \rangle$ is the fraction of inputs on which f, g agree minus the fraction of inputs on which they disagree.

$$2\epsilon \leq \hat{f}_{\alpha} = \langle f, \chi_{\alpha} \rangle = \text{agree} - \text{disagree} = 2\text{agree} - 1$$

This gives that the agreement between f and χ_{α} is at least $\frac{1}{2} + \epsilon$.

Linearity Test

$$\Pr_{x,y}[f(x \circ y) = f(x)f(y)] \geq \frac{1}{2} + \epsilon$$

means that the fraction of inputs x, y on which $f(x \circ y)$ and $f(x)f(y)$ agree is at least $1/2 + \epsilon$.

This gives

$$\begin{aligned} E_{x,y}[f(x \circ y)f(x)f(y)] &= \text{agreement} - \text{disagreement} \\ &= 2\text{agreement} - 1 \\ &\geq 2\epsilon \end{aligned}$$

$$\begin{aligned}
2\epsilon &\leq E_{x,y} \left[f(x \circ y) f(x) f(y) \right] \\
&= E_{x,y} \left[\left(\sum_{\alpha} \hat{f}_{\alpha} \chi_{\alpha}(x \circ y) \right) \cdot \left(\sum_{\beta} \hat{f}_{\beta} \chi_{\beta}(x) \right) \cdot \left(\sum_{\gamma} \hat{f}_{\gamma} \chi_{\gamma}(y) \right) \right] \\
&= E_{x,y} \left[\sum_{\alpha,\beta,\gamma} \hat{f}_{\alpha} \hat{f}_{\beta} \hat{f}_{\gamma} \chi_{\alpha}(x) \chi_{\alpha}(y) \chi_{\beta}(x) \chi_{\gamma}(y) \right] \\
&= \sum_{\alpha,\beta,\gamma} \hat{f}_{\alpha} \hat{f}_{\beta} \hat{f}_{\gamma} \cdot E_x \left[\chi_{\alpha}(x) \chi_{\beta}(x) \right] E_y \left[\chi_{\alpha}(y) \chi_{\gamma}(y) \right] \\
&= \sum_{\alpha} \hat{f}_{\alpha}^3 \\
&\leq \max_{\alpha} \hat{f}_{\alpha} \cdot \sum_{\alpha} \hat{f}_{\alpha}^2 = \max_{\alpha} \hat{f}_{\alpha}
\end{aligned}$$

Approximation Preserving Reductions

AP-reduction

- ▶ $x \in I_1 \Rightarrow f(x, r) \in I_2$
- ▶ $SOL_1(x) \neq \emptyset \Rightarrow SOL_2(f(x, r)) \neq \emptyset$
- ▶ $y \in SOL_2(f(x, r)) \Rightarrow g(x, y, r) \in SOL_2(x)$
- ▶ f, g are polynomial time computable
- ▶ $R_2(f(x, r), y) \leq r \Rightarrow R_1(x, g(x, y, r)) \leq 1 + \alpha(r - 1)$

Label Cover

Input:

- ▶ bipartite graph $G = (V_1, V_2, E)$
- ▶ label sets L_1, L_2
- ▶ for every edge $(u, v) \in E$ a relation $R_{u,v} \subseteq L_1 \times L_2$ that describe assignments that make the edge **happy**.
- ▶ maximize number of happy edges

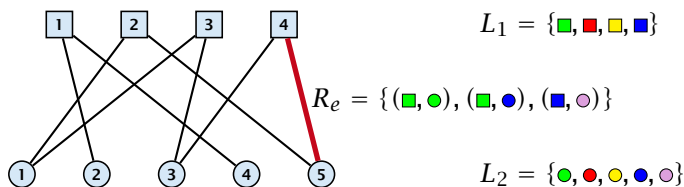

The label cover problem also has its origin in proof systems. It encodes a 2PR1 (2 prover 1 round system). Each side of the graph corresponds to a prover. An edge is a query consisting of a question for prover 1 and prover 2. If the answers are consistent the verifier accepts otherwise it rejects.

Label Cover

- ▶ an instance of label cover is (d_1, d_2) -regular if every vertex in L_1 has degree d_1 and every vertex in L_2 has degree d_2 .
- ▶ if every vertex has the same degree d the instance is called d -regular

Minimization version:

- ▶ assign a set $L_x \subseteq L_1$ of labels to every node $x \in L_1$ and a set $L_y \subseteq L_2$ to every node $y \in L_2$
- ▶ make sure that for every edge (x, y) there is $\ell_x \in L_x$ and $\ell_y \in L_y$ s.t. $(\ell_x, \ell_y) \in R_{x,y}$
- ▶ minimize $\sum_{x \in L_1} |L_x| + \sum_{y \in L_2} |L_y|$ (total labels used)

MAX E3SAT via Label Cover

instance:

$$\Phi(x) = (x_1 \vee \bar{x}_2 \vee x_3) \wedge (x_4 \vee x_2 \vee \bar{x}_3) \wedge (\bar{x}_1 \vee x_2 \vee \bar{x}_4)$$

corresponding graph:

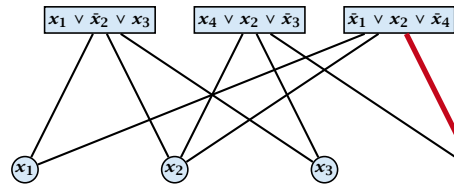

The verifier accepts if the labelling (assignment to variables in clauses at the top + assignment to variables at the bottom) causes the clause to evaluate to true and is consistent, i.e., the assignment of e.g. x_4 at the bottom is the same as the assignment given to x_4 in the labelling of the clause.

label sets: $L_1 = \{T, F\}^3, L_2 = \{T, F\}$ (T =true, F =false)

relation: $R_{C,x_i} = \{(u_i, u_j, u_k), u_i\}$, where the clause C is over variables x_i, x_j, x_k and assignment (u_i, u_j, u_k) satisfies C

$$R = \{((F, F, F), F), ((F, T, F), F), ((F, F, T), T), ((F, T, T), T), ((T, T, T), T), ((T, T, F), F), ((T, F, F), F)\}$$

MAX E3SAT via Label Cover

Lemma 109

If we can satisfy k out of m clauses in ϕ we can make at least $3k + 2(m - k)$ edges happy.

Proof:

- ▶ for V_2 use the setting of the assignment that satisfies k clauses
- ▶ for satisfied clauses in V_1 use the corresponding assignment to the clause-variables (gives $3k$ happy edges)
- ▶ for unsatisfied clauses flip assignment of one of the variables; this makes one incident edge unhappy (gives $2(m - k)$ happy edges)

MAX E3SAT via Label Cover

Lemma 110

If we can satisfy at most k clauses in Φ we can make at most $3k + 2(m - k) = 2m + k$ edges happy.

Proof:

- ▶ the labeling of nodes in V_2 gives an assignment
- ▶ every unsatisfied clause in this assignment cannot be assigned a label that satisfies all 3 incident edges
- ▶ hence at most $3m - (m - k) = 2m + k$ edges are happy

Hardness for Label Cover

Here $\epsilon > 0$ is the constant from PCP Theorem A.

We cannot distinguish between the following two cases

- ▶ all $3m$ edges can be made happy
- ▶ at most $2m + (1 - \epsilon)m = (3 - \epsilon)m$ out of the $3m$ edges can be made happy

Hence, we cannot obtain an approximation constant $\alpha > \frac{3-\epsilon}{3}$.

(3, 5)-regular instances

Theorem 111

There is a constant ρ s.t. MAXE3SAT is hard to approximate with a factor of ρ even if restricted to instances where a variable appears in exactly 5 clauses.

Then our reduction has the following properties:

- ▶ the resulting Label Cover instance is (3, 5)-regular
- ▶ it is hard to approximate for a constant $\alpha < 1$
- ▶ given a label ℓ_1 for x there is at most one label ℓ_2 for y that makes edge (x, y) happy (**uniqueness property**)

(3, 5)-regular instances

The previous theorem can be obtained with a series of **gap-preserving reductions**:

- ▶ $\text{MAX3SAT} \leq \text{MAX3SAT}(\leq 29)$
- ▶ $\text{MAX3SAT}(\leq 29) \leq \text{MAX3SAT}(\leq 5)$
- ▶ $\text{MAX3SAT}(\leq 5) \leq \text{MAX3SAT}(= 5)$
- ▶ $\text{MAX3SAT}(= 5) \leq \text{MAXE3SAT}(= 5)$

Here $\text{MAX3SAT}(\leq 29)$ is the variant of MAX3SAT in which a variable appears in at most 29 clauses. Similar for the other problems.

Regular instances

We take the (3, 5)-regular instance. We make 3 copies of every clause vertex and 5 copies of every variable vertex. Then we add edges between clause vertex and variable vertex iff the clause contains the variable. This increases the size by a constant factor. The gap instance can still either only satisfy a constant fraction of the edges or all edges. The uniqueness property still holds for the new instance.

Theorem 112

There is a constant $\alpha < 1$ such if there is an α -approximation algorithm for Label Cover on 15-regular instances than $P=NP$.

Given a label ℓ_1 for $x \in V_1$ there is at most one label ℓ_2 for y that makes (x, y) happy. (**uniqueness property**)

Parallel Repetition

We would like to increase the inapproximability for Label Cover.

In the verifier view, in order to decrease the acceptance probability of a wrong proof (or as here: a pair of wrong proofs) one could repeat the verification several times.

Unfortunately, we have a 2P1R-system, i.e., we are stuck with a single round and cannot simply repeat.

The idea is to use **parallel repetition**, i.e., we simply play several rounds in parallel and hope that the acceptance probability of wrong proofs goes down.

Parallel Repetition

Given Label Cover instance I with $G = (V_1, V_2, E)$, label sets L_1 and L_2 we construct a new instance I' :

- ▶ $V'_1 = V_1^k = V_1 \times \dots \times V_1$
- ▶ $V'_2 = V_2^k = V_2 \times \dots \times V_2$
- ▶ $L'_1 = L_1^k = L_1 \times \dots \times L_1$
- ▶ $L'_2 = L_2^k = L_2 \times \dots \times L_2$
- ▶ $E' = E^k = E \times \dots \times E$

An edge $((x_1, \dots, x_k), (y_1, \dots, y_k))$ whose end-points are labelled by $(\ell_1^x, \dots, \ell_k^x)$ and $(\ell_1^y, \dots, \ell_k^y)$ is happy if $(\ell_i^x, \ell_i^y) \in R_{x_i, y_i}$ for all i .

Parallel Repetition

If I is regular than also I' .

If I has the uniqueness property than also I' .

Did the gap increase?

- ▶ Suppose we have labelling ℓ_1, ℓ_2 that satisfies just an α -fraction of edges in I .
- ▶ We transfer this labelling to instance I' :
vertex (x_1, \dots, x_k) gets label $(\ell_1(x_1), \dots, \ell_1(x_k))$,
vertex (y_1, \dots, y_k) gets label $(\ell_2(y_1), \dots, \ell_2(y_k))$.
- ▶ **How many edges are happy?**
only $(\alpha|E|)^k$ out of $|E|^k$!!! (just an α^k fraction)

Does this always work?

Counter Example

Non interactive agreement:

- ▶ Two provers A and B
- ▶ The verifier generates two random bits b_A , and b_B , and sends one to A and one to B .
- ▶ Each prover has to answer one of A_0, A_1, B_0, B_1 with the meaning $A_0 :=$ prover A has been given a bit with value 0.
- ▶ The provers win if they give **the same answer** and if the **answer is correct**.

Counter Example

The provers can win with probability at most $1/2$.

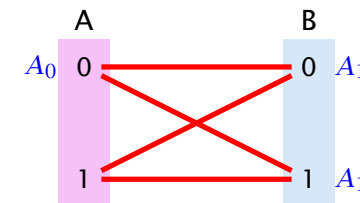

Regardless what we do 50% of edges are unhappy!

Counter Example

In the repeated game the provers can also win with probability $1/2$:

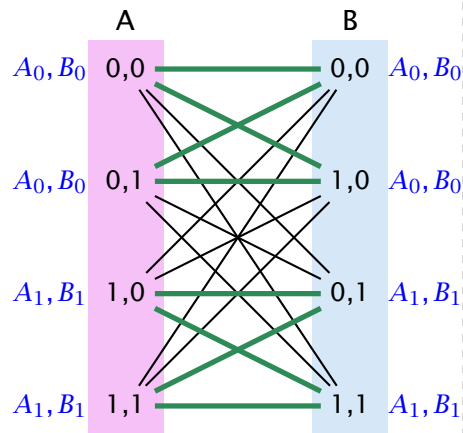

For the first game/coordinate the provers give an answer of the form "A has received..." (A_0 or A_1) and for the second an answer of the form "B has received..." (B_0 or B_1).

If the answer a prover has to give is about himself a prover can answer correctly. If the answer to be given is about the other prover the same bit is returned. This means e.g. Prover B answers A_1 for the first game iff in the second game he receives a 1-bit.

By this method the provers always win if Prover A gets the same bit in the first game as Prover B in the second game. This happens with probability $1/2$.

This strategy is not possible for the provers if the game is repeated sequentially. How should prover B know (for her answer in the first game) which bit she is going to receive in the second game?

Boosting

Theorem 113

There is a constant $c > 0$ such if $\text{OPT}(I) = |E|(1 - \delta)$ then $\text{OPT}(I') \leq |E'|(1 - \delta)^{\frac{ck}{\log L}}$, where $L = |L_1| + |L_2|$ denotes total number of labels in I .

proof is highly non-trivial

Hardness of Label Cover

Theorem 114

There are constants $c > 0$, $\delta < 1$ s.t. for any k we cannot distinguish regular instances for Label Cover in which either

- ▶ $\text{OPT}(I) = |E|$, or
- ▶ $\text{OPT}(I) = |E|(1 - \delta)^{ck}$

unless each problem in NP has an algorithm running in time $\mathcal{O}(n^{\mathcal{O}(k)})$.

Corollary 115

There is no α -approximation for Label Cover for **any** constant α .

Hardness of Set Cover

Theorem 116

There exist regular Label Cover instances s.t. we cannot distinguish whether

- ▶ all edges are satisfiable, or
 - ▶ at most a $1/\log^2(|L_1||E|)$ -fraction is satisfiable
- unless NP-problems have algorithms with running time $\mathcal{O}(n^{\mathcal{O}(\log \log n)})$.

choose $k \geq \frac{2}{c} \log_{1/(1-\delta)}(\log(|L_1||E|)) = \mathcal{O}(\log \log n)$.

Hardness of Set Cover

Partition System (s, t, h)

- ▶ universe U of size s
- ▶ t pairs of sets $(A_1, \bar{A}_1), \dots, (A_t, \bar{A}_t)$;
 $A_i \subseteq U, \bar{A}_i = U \setminus A_i$
- ▶ choosing from any h pairs only one of A_i, \bar{A}_i we do not cover the whole set U

we will show later:

for any h, t with $h \leq t$ there exist systems with $s = |U| \leq 4t^{2^2h}$

Hardness of Set Cover

Given a Label Cover instance we construct a Set Cover instance;

The universe is $E \times U$, where U is the universe of some partition system; ($t = |L_1|, h = \log(|E||L_1|)$)

for all $u \in V_1, \ell_1 \in L_1$

$$S_{u, \ell_1} = \{(u, v), a \mid (u, v) \in E, a \in A_{\ell_1}\}$$

for all $v \in V_2, \ell_2 \in L_2$

$$S_{v, \ell_2} = \{(u, v), a \mid (u, v) \in E, a \in \bar{A}_{\ell_2}, \text{ where } (\ell_1, \ell_2) \in R_{(u, v)}\}$$

note that S_{v, ℓ_2} is well defined because of uniqueness property

Hardness of Set Cover

Suppose that we can make all edges happy.

Choose sets S_{u, ℓ_1} 's and S_{v, ℓ_2} 's, where ℓ_1 is the label we assigned to u , and ℓ_2 the label for v . ($|V_1| + |V_2|$ sets)

For an edge (u, v) , S_{v, ℓ_2} contains $\{(u, v)\} \times A_{\ell_2}$. For a happy edge S_{u, ℓ_1} contains $\{(u, v)\} \times \bar{A}_{\ell_2}$.

Since all edges are happy we have covered the whole universe.

If the Label Cover instance is completely satisfiable we can cover with $|V_1| + |V_2|$ sets.

Hardness of Set Cover

Lemma 117

Given a solution to the set cover instance using at most $\frac{h}{8}(|V_1| + |V_2|)$ sets we can find a solution to the Label Cover instance satisfying at least $\frac{2}{h^2}|E|$ edges.

If the Label Cover instance cannot satisfy a $2/h^2$ -fraction we cannot cover with $\frac{h}{8}(|V_1| + |V_2|)$ sets.

Since differentiating between both cases for the Label Cover instance is hard, we have an $\mathcal{O}(h)$ -hardness for Set Cover.

Hardness of Set Cover

- ▶ n_u : number of $S_{u,i}$'s in cover
- ▶ n_v : number of $S_{v,j}$'s in cover
- ▶ at most $1/4$ of the vertices can have $n_u, n_v \geq h/2$; mark these vertices
- ▶ at least half of the edges have both end-points unmarked, as the graph is regular
- ▶ for such an edge (u, v) we must have chosen $S_{u,i}$ and a corresponding $S_{v,j}$, s.t. $(i, j) \in R_{u,v}$ (making (u, v) happy)
- ▶ we choose a random label for u from the (at most $h/2$) chosen $S_{u,i}$ -sets and a random label for v from the (at most $h/2$) $S_{v,j}$ -sets
- ▶ (u, v) gets happy with probability at least $4/h^2$
- ▶ hence we make a $2/h^2$ -fraction of edges happy

Set Cover

Theorem 118

There is no $\frac{1}{32} \log n$ -approximation for the unweighted Set Cover problem unless problems in NP can be solved in time $\mathcal{O}(n^{\Theta(\log \log n)})$.

Given label cover instance (V_1, V_2, E) , label sets L_1 and L_2 ;

Set $h = \log(|E||L_1|)$ and $t = |L_1|$; Size of partition system is

$$s = |U| = 4t^2 2^h = 4|L_1|^2 (|E||L_1|)^2 = 4|E|^2 |L_1|^4$$

The size of the ground set is then

$$n = |E||U| = 4|E|^3 |L_2|^4 \leq (|E||L_2|)^4$$

for sufficiently large $|E|$. Then $h \geq \frac{1}{4} \log n$.

If we get an instance where all edges are satisfiable there exists a cover of size only $|V_1| + |V_2|$.

If we find a cover of size at most $\frac{h}{8}(|V_1| + |V_2|)$ we can use this to satisfy at least a fraction of $2/h^2 \geq 1/\log^2(|E||L_1|)$ of the edges. **this is not possible...**

Partition Systems

Lemma 119

Given h and t with $h \leq t$, there is a partition system of size $s = \ln(4t)h2^h \leq 4t^2 2^h$.

We pick t sets at random from the possible $2^{|U|}$ subsets of U .

Fix a choice of h of these sets, and a choice of h bits (whether we choose A_i or \bar{A}_i). There are $2^h \cdot \binom{t}{h}$ such choices.

What is the probability that a given choice covers U ?

The probability that an element $u \in A_i$ is $1/2$ (same for \bar{A}_i).

The probability that u is covered is $1 - \frac{1}{2^h}$.

The probability that all u are covered is $(1 - \frac{1}{2^h})^s$

The probability that there exists a choice such that all u are covered is at most

$$\binom{t}{h} 2^h \left(1 - \frac{1}{2^h}\right)^s \leq (2t)^h e^{-s/2^h} = (2t)^h \cdot e^{-h \ln(4t)} < \frac{1}{2}.$$

The random process outputs a partition system with constant probability!

Advanced PCP Theorem

Here the verifier reads exactly three bits from the proof. Not $O(3)$ bits.

Theorem 120

For any positive constant $\epsilon > 0$, it is the case that $\text{NP} \subseteq \text{PCP}_{1-\epsilon, 1/2+\epsilon}(\log n, 3)$. Moreover, the verifier just reads three bits from the proof, and bases its decision only on the parity of these bits.

It is NP-hard to approximate a MAXE3LIN problem by a factor better than $1/2 + \delta$, for any constant δ .

It is NP-hard to approximate MAX3SAT better than $7/8 + \delta$, for any constant δ .