

7.5 Skip Lists

Why do we not use a list for implementing the ADT Dynamic Set?

- ▶ time for search $\Theta(n)$
- ▶ time for insert $\Theta(n)$ (dominated by searching the item)
- ▶ time for delete $\Theta(1)$ if we are given a handle to the object, otw. $\Theta(n)$

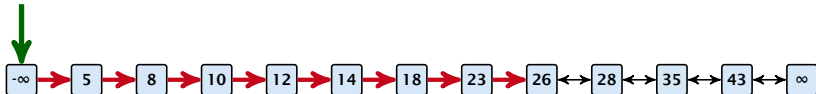

7.5 Skip Lists

How can we improve the search-operation?

Add an express lane:

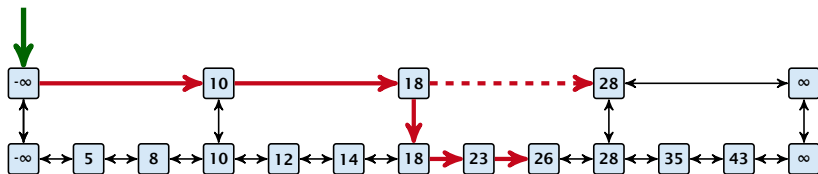

Let $|L_1|$ denote the number of elements in the “express lane”, and $|L_0| = n$ the number of all elements (ignoring dummy elements).

Worst case search time: $|L_1| + \frac{|L_0|}{|L_1|}$ (ignoring additive constants)

Choose $|L_1| = \sqrt{n}$. Then search time $\Theta(\sqrt{n})$.

7.5 Skip Lists

Add more express lanes. Lane L_i contains roughly every $\frac{L_{i-1}}{L_i}$ -th item from list L_{i-1} .

Search(x) ($k + 1$ lists L_0, \dots, L_k)

- ▶ Find the largest item in list L_k that is smaller than x . At most $|L_k| + 2$ steps.
- ▶ Find the largest item in list L_{k-1} that is smaller than x . At most $\lceil \frac{|L_{k-1}|}{|L_k|+1} \rceil + 2$ steps.
- ▶ Find the largest item in list L_{k-2} that is smaller than x . At most $\lceil \frac{|L_{k-2}|}{|L_{k-1}|+1} \rceil + 2$ steps.
- ▶ ...
- ▶ At most $|L_k| + \sum_{i=1}^k \frac{L_{i-1}}{L_i} + 3(k + 1)$ steps.

7.5 Skip Lists

Choose ratios between list-lengths evenly, i.e., $\frac{|L_{i-1}|}{|L_i|} = r$, and, hence, $L_k \approx r^{-k}n$.

Worst case running time is: $\mathcal{O}(r^{-k}n + kr)$.

Choose $r = n^{\frac{1}{k+1}}$. Then

$$\begin{aligned}r^{-k}n + kr &= \left(n^{\frac{1}{k+1}}\right)^{-k}n + kn^{\frac{1}{k+1}} \\ &= n^{1-\frac{k}{k+1}} + kn^{\frac{1}{k+1}} \\ &= (k+1)n^{\frac{1}{k+1}}.\end{aligned}$$

Choosing $k = \Theta(\log n)$ gives a logarithmic running time.

7.5 Skip Lists

How to do insert and delete?

- ▶ If we want that in L_i we always skip over roughly the same number of elements in L_{i-1} an insert or delete may require a lot of re-organisation.

Use randomization instead!

7.5 Skip Lists

Insert:

- ▶ A search operation gives you the insert position for element x in every list.
- ▶ Flip a coin until it shows head, and record the number $t \in \{1, 2, \dots\}$ of trials needed.
- ▶ Insert x into lists L_0, \dots, L_{t-1} .

Delete:

- ▶ You get all predecessors via backward pointers.
- ▶ Delete x in all lists it actually appears in.

The time for both operations is dominated by the search time.

7.5 Skip Lists

Insert (35):

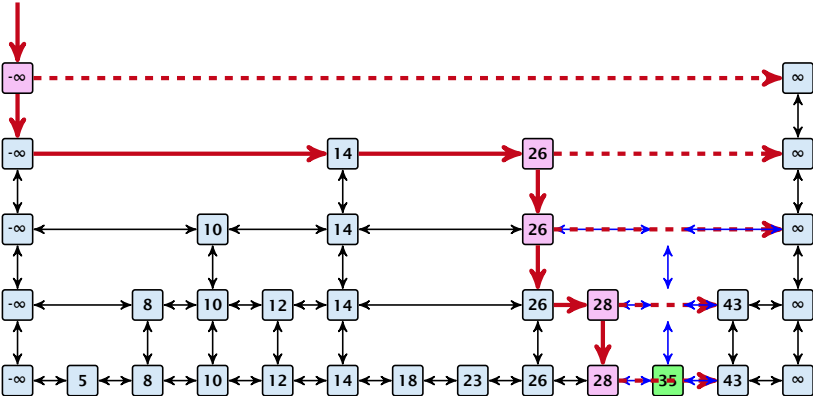

High Probability

Definition 1 (High Probability)

We say a **randomized** algorithm has running time $\mathcal{O}(\log n)$ with **high probability** if for any constant α the running time is at most $\mathcal{O}(\log n)$ with probability at least $1 - \frac{1}{n^\alpha}$.

Here the \mathcal{O} -notation hides a constant that may depend on α .

High Probability

Suppose there are **polynomially** many events E_1, E_2, \dots, E_ℓ , $\ell = n^c$ each holding with high probability (e.g. E_i may be the event that the i -th search in a skip list takes time at most $\mathcal{O}(\log n)$).

Then the probability that all E_i hold is at least

$$\begin{aligned}\Pr[E_1 \wedge \dots \wedge E_\ell] &= 1 - \Pr[\bar{E}_1 \vee \dots \vee \bar{E}_\ell] \\ &\geq 1 - n^c \cdot n^{-\alpha} \\ &= 1 - n^{c-\alpha} .\end{aligned}$$

This means $\Pr[E_1 \wedge \dots \wedge E_\ell]$ holds with high probability.

7.5 Skip Lists

Lemma 2

A search (and, hence, also insert and delete) in a skip list with n elements takes time $\mathcal{O}(\log n)$ with high probability (w. h. p.).

7.5 Skip Lists

Backward analysis:

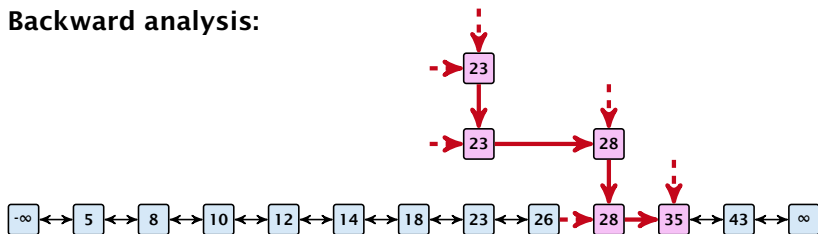

At each point the path goes up with probability $1/2$ and left with probability $1/2$.

We show that w.h.p:

- ▶ A “long” search path must also go very high.
- ▶ There are no elements in high lists.

From this it follows that w.h.p. there are no long paths.

7.5 Skip Lists

Estimation for Binomial Coefficients

$$\left(\frac{n}{k}\right)^k \leq \binom{n}{k} \leq \left(\frac{en}{k}\right)^k$$

$$\binom{n}{k} = \frac{n!}{k! \cdot (n-k)!} = \frac{n \cdot \dots \cdot (n-k+1)}{k \cdot \dots \cdot 1} \geq \left(\frac{n}{k}\right)^k$$

$$\begin{aligned} \binom{n}{k} &= \frac{n \cdot \dots \cdot (n-k+1)}{k!} \leq \frac{n^k}{k!} = \frac{n^k \cdot k^k}{k^k \cdot k!} \\ &= \left(\frac{n}{k}\right)^k \cdot \frac{k^k}{k!} \leq \left(\frac{n}{k}\right)^k \cdot \sum_{i \geq 0} \frac{k^i}{i!} = \left(\frac{en}{k}\right)^k \end{aligned}$$

7.5 Skip Lists

Let $E_{z,k}$ denote the event that a search path is of length z (number of edges) but does not visit a list above L_k .

In particular, this means that during the construction in the backward analysis we see at most k heads (i.e., coin flips that tell you to go up) in z trials.

7.5 Skip Lists

$$\Pr[E_{z,k}] \leq \Pr[\text{at most } k \text{ heads in } z \text{ trials}]$$

$$\leq \binom{z}{k} 2^{-(z-k)} \leq \left(\frac{ez}{k}\right)^k 2^{-(z-k)} \leq \left(\frac{2ez}{k}\right)^k 2^{-z}$$

choosing $k = \gamma \log n$ with $\gamma \geq 1$ and $z = (\beta + \alpha)\gamma \log n$

$$\leq \left(\frac{2ez}{k}\right)^k 2^{-\beta k} \cdot n^{-\gamma\alpha} \leq \left(\frac{2ez}{2^\beta k}\right)^k \cdot n^{-\alpha}$$

$$\leq \left(\frac{2e(\beta + \alpha)}{2^\beta}\right)^k n^{-\alpha}$$

now choosing $\beta = 6\alpha$ gives

$$\leq \left(\frac{42\alpha}{64\alpha}\right)^k n^{-\alpha} \leq n^{-\alpha}$$

for $\alpha \geq 1$.

7.5 Skip Lists

So far we fixed $k = \gamma \log n$, $\gamma \geq 1$, and $z = 7\alpha\gamma \log n$, $\alpha \geq 1$.

This means that a search path of length $\Omega(\log n)$ visits a list on a level $\Omega(\log n)$, w.h.p.

Let A_{k+1} denote the event that the list L_{k+1} is non-empty. Then

$$\Pr[A_{k+1}] \leq n2^{-(k+1)} \leq n^{-(\gamma-1)} .$$

For the search to take at least $z = 7\alpha\gamma \log n$ steps either the event $E_{z,k}$ or the event A_{k+1} must hold.

Hence,

$$\begin{aligned} \Pr[\text{search requires } z \text{ steps}] &\leq \Pr[E_{z,k}] + \Pr[A_{k+1}] \\ &\leq n^{-\alpha} + n^{-(\gamma-1)} \end{aligned}$$

This means, the search requires at most z steps, w. h. p.

Skip Lists

Bibliography

[GT98] Michael T. Goodrich, Roberto Tamassia
Data Structures and Algorithms in JAVA,
John Wiley, 1998

Skip lists are covered in Chapter 7.5 of [GT98].